

KELOX

KMP451 KELOX-PROTEC union with male thread 20x1/2"

73241D02

Areas of application

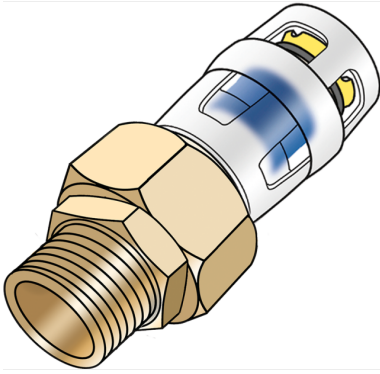

Plug-in union with male thread made from stainless steel, thread as per ÖNORM EN 10226, for connecting to fittings, made of dezincification-resistant brass (DZR), including push-on sleeve made of transparent polyamide, O-rings, withdrawal barriers and a protector ring as an insertion locking device; flat-sealing including seal

Approvals:



Specifications

Article information

port 1	Plug-in
port 2	Male thread metric
design	Miscellaneous

Technical properties

maximum working pressure at 20 ° C	10 bar
------------------------------------	--------

Product information

VPE1	10,00 SA1
VPE2	100,00 KT1
weight	0,162 KGM
text	KELOX-PROTEC union with male thread
INTRNR	74122000
main material group	KELOX
material group	KELOX-PROtec pushfittings
code	KMP451



Art. No	label	d1 mm	L1 mm	z1 mm	z2 mm	slw1 mm
73241D02	20x1/2"	20	50,5	14,5	33	30