

# STEELOX

## SMX457 ?STEELOX adapter with female thread 20x3/4"

57206D04

### Areas of application

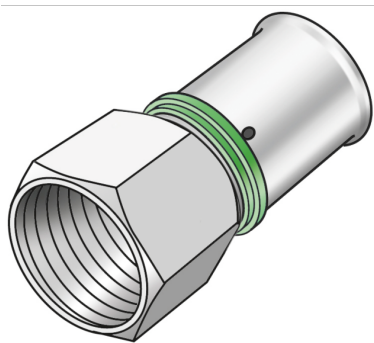

?Press-fit adapter with female thread, made of non-porous metallised dezincification-resistant brass (DZR), incl. support sleeves with O-rings and stainless steel pressing sleeves, "leak before pressed" for d16–50mm

DO NOT join threaded pipe or malleable iron fittings!

## Approvals:



# Specifications

## Article information

port 1	Pressing socket
port 2	Female thread cylindrical BSPT-Rp (ISO 7-1)
execution	1-part
design	Straight
press contour	SX

## Technical properties

maximum working pressure at 20 ° C	10 bar
------------------------------------	--------

## Product information

VPE1	10,00 SA1
VPE2	180,00 KT1
weight	0,087 KGM
text	?STEELOX adapter with female thread
INTRNR	74122000
code	SMX457

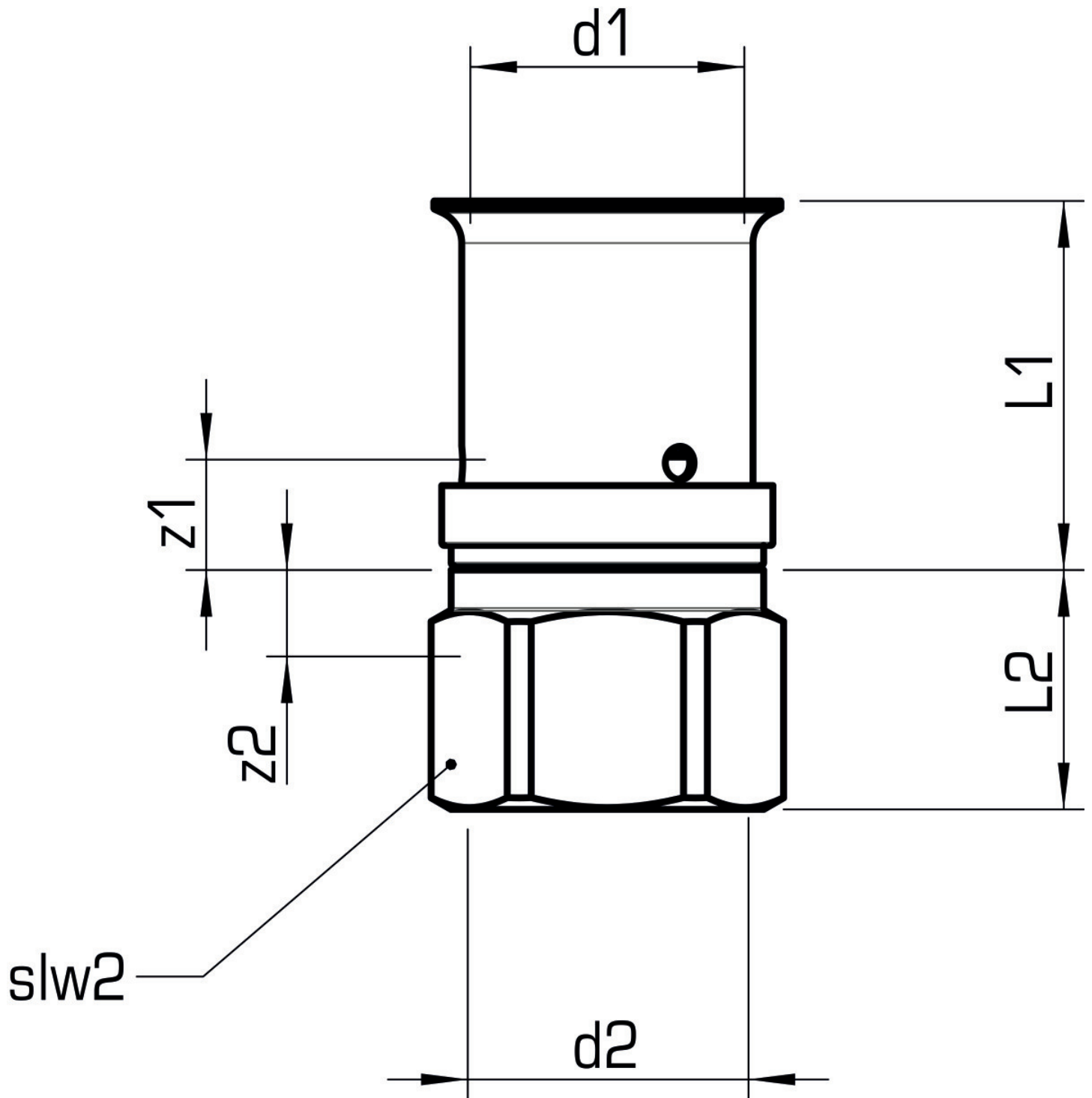

Art. No	label	d2 Inches	d1 mm	L1 mm	L2 mm	z1 mm	z2 mm	slw1 mm	slw2 mm
57206D04	20x3/4"	3/4" (20)	20	30	16	16	4	32	32



**KE KELIT GmbH**

A 4020 Linz, Ignaz-Mayer-Straße 17, Austria, Europe

**PHONE** +43 (0) 50 779 **E-MAIL** [office@kekelit.com](mailto:office@kekelit.com)

[www.kekelit.com](http://www.kekelit.com)