

# CLIMATE FIX

## KCP558A CLIMATEFIX climate hydraulic box with shut-off 16

6353616

### Areas of application

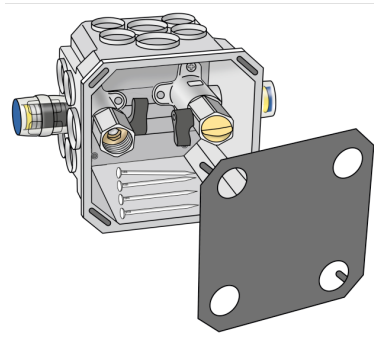

Climate hydraulic box for subsequent hydraulic connection of ceiling panels to the heating or cooling system with shut-off

Climate hydraulic box consisting of:

Plastic box for wood and steel formwork in in-situ concrete,

2 PROTEC wall bracket fittings with 2 ball valves 1/2° female thread

4 stainless steel nails 120mm and construction protective cover, pre-installed in the climate box

Dimensions: L: 115mm W: 115mm H: 102mm

Accessories: KCP558S climate-hydraulic box, transparent lid 130x130x3.5mm

# Specifications

Product information	
VPE1	1,00 STK
VPE2	4,00 KT1
weight	0,780 KGM
text	CLIMATEFIX climate hydraulic box with shut-off
INTRNR	39232100
main material group	CLIMATEFIX
material group	CLIMATEFIX fittings
code	KCP558A

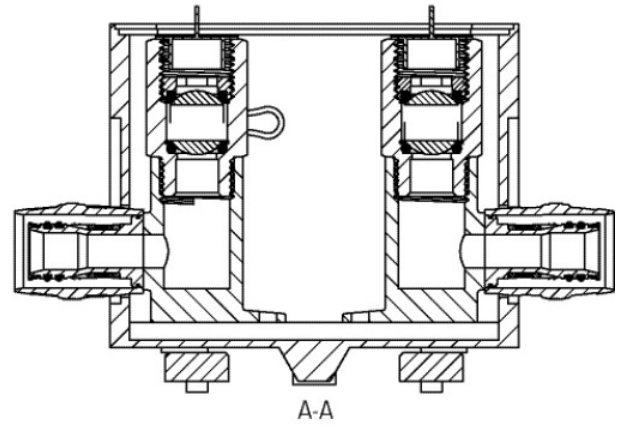
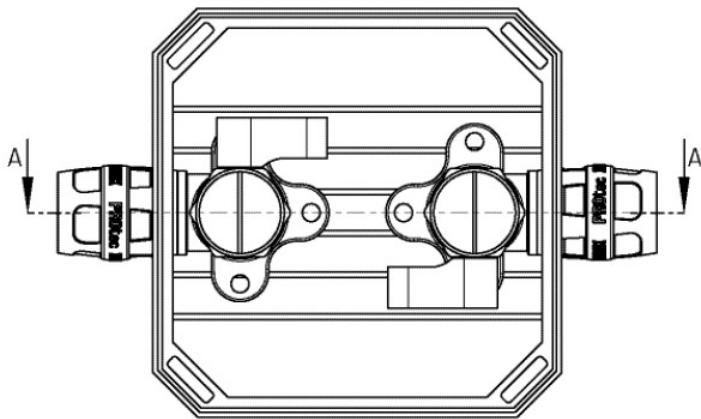
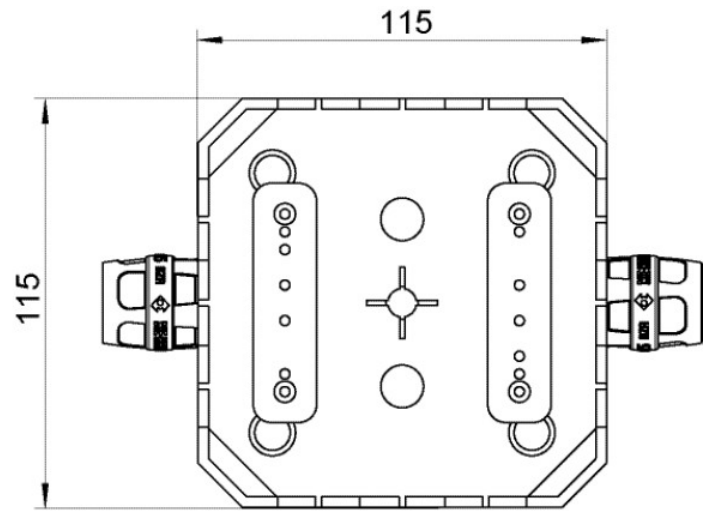
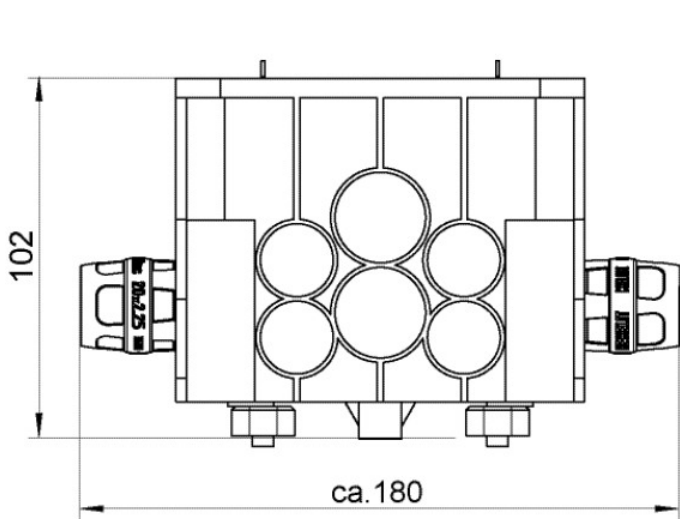

Art. No	label
6353616	16