

LEXEL

LX09 LEXEL insulation hose - 9 25

5120045

Areas of application

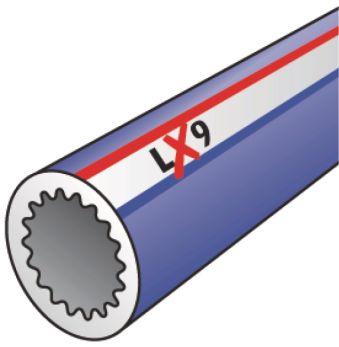

Insulation hose made of cross-linked closed-cell polyethylene with onto it extruded woven tape fabric and viscoplastic protective film, for heat and structure-borne insulation, sound insulation increased with a knob-air chamber profile on the inside of the hose, CFC-free

Colour: blue

Length: 2m

Thickness: 9mm

Specifications

Technical properties

thermal conductivity 0,036 W/(m.K)

Product information

DIM2 25

VPE1 140,00 KT1

L 2 m

weight 0,049 KGM

text LEXEL insulation hose - 9

INTRNR 39173900

main material group LEXEL

material group LEXEL isolation and accessories

code LX09

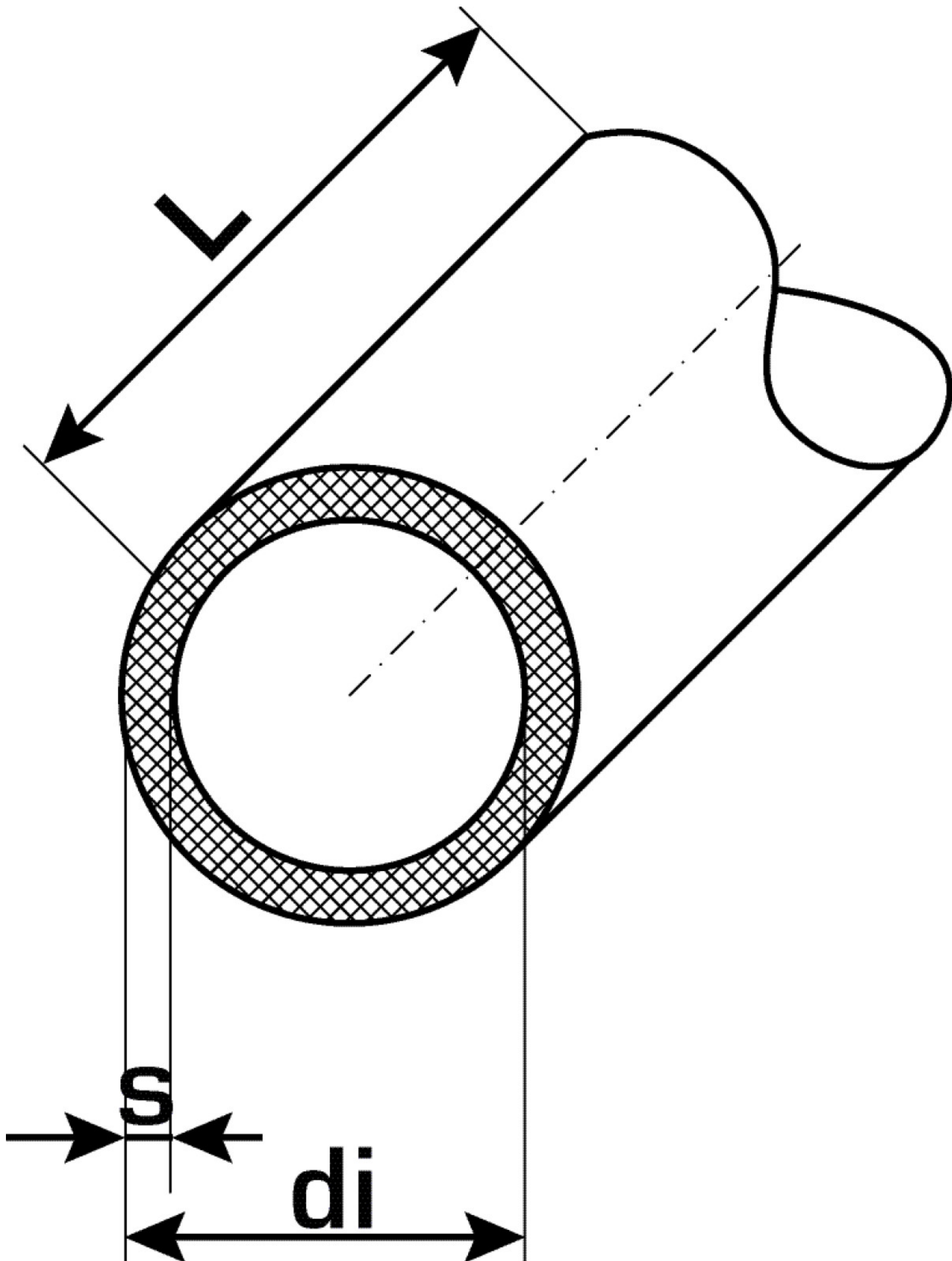

Art. No	label	d mm
5120045	25	25



KE KELIT GmbH

A 4020 Linz, Ignaz-Mayer-Straße 17, Austria, Europe

PHONE +43 (0) 50 779 **E-MAIL** office@kekelit.com

www.kekelit.com