

LEXEL

LX13 LEXEL insulation hose - 13 32

5130055

Areas of application

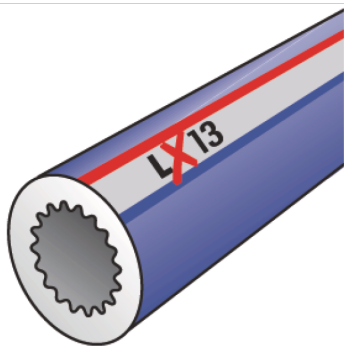

Insulation hose made of cross-linked closed-cell polyethylene with onto it extruded woven tape fabric and viscoplastic protective film, for heat and structure-borne insulation, sound insulation increased with a knob-air chamber profile on the inside of the hose, CFC-free

Colour: blue

Length: 2m

Thickness: 13mm

Specifications

Technical properties

thermal conductivity 0,036 W/(m.K)

Product information

VPE1 80,00 KT1

L 2 m

weight 0,088 KGM

text LEXEL insulation hose - 13

INTRNR 39173900

main material group LEXEL

material group LEXEL isolation and accessories

code LX13

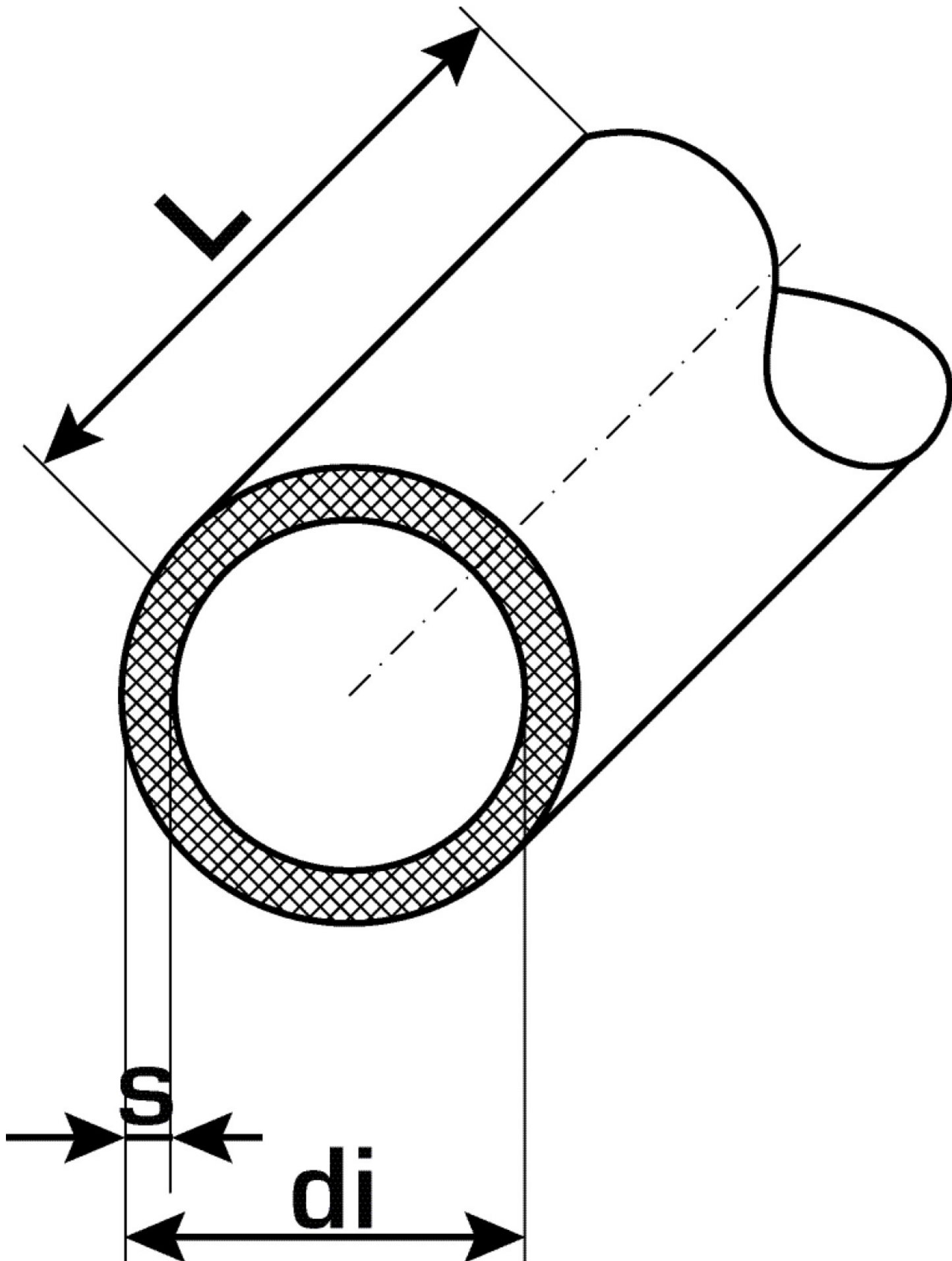

Art. No	label	d mm
5130055	32	32



KE KELIT GmbH

A 4020 Linz, Ignaz-Mayer-Straße 17, Austria, Europe

PHONE +43 (0) 50 779 **E-MAIL** office@kekelit.com

www.kekelit.com