

LEXEL

LX52 LEXEL insulating strips 70mm

5200020

Areas of application

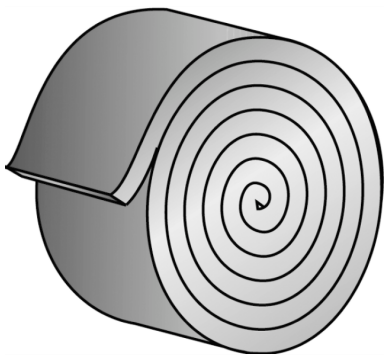

Insulation strip without glue, made of cross-linked closed-cell polyethylene with onto it extruded viscoplastic protective film for heat and structure-borne insulation, CFC-free. For subsequent insulation of fittings and joints

Roll length: 3m

Thickness: 3mm

Colour: blue

Specifications

Product information	
VPE1	300,00 KT1
L	3 m
weight	0,015 KGM
text	LEXEL insulating strips
INTRNR	39211900
main material group	LEXEL
material group	LEXEL isolation and accessories
code	LX52



Art. No	label
5200020	70mm



KE KELIT GmbH
A 4020 Linz, Ignaz-Mayer-Straße 17, Austria, Europe
PHONE +43 (0) 50 779 **E-MAIL** office@kekelit.com
www.kekelit.com