

K19A KELIT seal set for loose flange KE18 - steel flange Dichtung 40

2730840

Areas of application

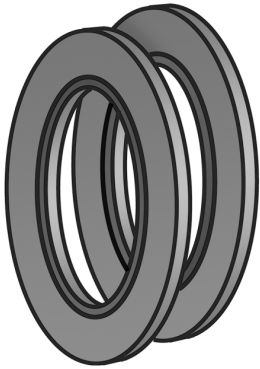

Incl. screws, nuts, spring washers, shims and EPDM seal with steel insert, screw length aligned with KE18 collar bushing with K19 loose flange mounted on steel flange
EPDM seal with steel insert available separately!

Approvals:



Specifications

Product information

VPE1	1 SA1
weight	0,026 KGM
text	KELIT seal set for loose flange KE18 - steel flange
INTRNR	40169300
main material group	KELEN
material group	KELEN accessories
code	K19A

Art. No

label

2730840

Dichtung 40



KE KELIT GmbH

A 4020 Linz, Ignaz-Mayer-Straße 17, Austria, Europe

PHONE +43 (0) 50 779 **E-MAIL** office@kekelit.com

www.kekelit.com