

# KELOX

KMU480K ? KMU480K KELOX-ULTRAX wall bracket fitting 90° with female thread, shortened 20x1/2"

71255D02

## Areas of application

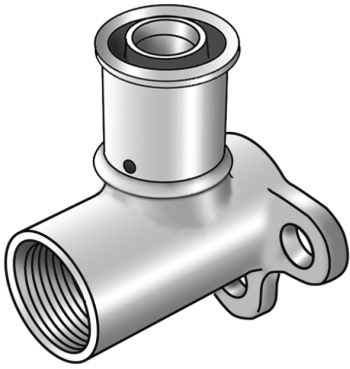

Press-fit wall bracket fitting with female thread, reduced by 5mm, made from non-porous metallised brass; including support sleeves with O-rings and steel or stainless steel press-fit sleeves, "leak before pressed"

Overall height:

1/2" - 36mm

DO NOT screw in threaded pipes and cast iron fittings!

## Approvals:



# Specifications

## Article information

port 1	Pressmuffe
design	Durchgängig rechtwinklig
press contour	U

## Technical properties

maximum working pressure at 20 ° C	10 bar
------------------------------------	--------

## Product information

VPE1	10,00 SA1
VPE2	100,00 KT1
weight	0,160 KGM
text	? KMU480K KELOX-ULTRAX wall bracket fitting 90° with female thread, shortened
INTRNR	74122000
main material group	KELOX
material group	KELOX-ULTRAX metal fittings
code	KMU480K



Art. No	label	d1 mm	L1 mm	L3 mm	z1 mm	z3 mm
71255D02	20x1/2"	20	42,5	20	17	15