

# KELOX

## KMP447X KELOX-PROTEC CLIX tee with branch female 32x1/2"

730240F02

### Areas of application

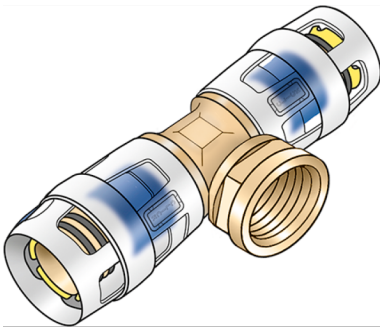

Plug-in tee with female thread, made of dezincification-resistant brass (DZR), including support sleeves with insertion click noise, as well as haptic and optical insertion indicator, O-rings, withdrawal barriers and a protector ring as an insertion locking device  
DO NOT screw in any threaded pipes and cast iron fittings!

## Approvals:



# Specifications

## Article information

port 1	Plug-in
port 2	Female thread metric
port 3	Plug-in
execution	Tee piece
angle	90 °

## Technical properties

maximum working pressure at 20 ° C	10 bar
------------------------------------	--------

## Product information

VPE1	4,00 SA1
VPE2	32,00 KT1
weight	0,312 KGM
text	KELOX-PROTEC CLIX tee with branch female
INTRNR	74122000
main material group	KELOX
material group	KELOX-PROtec pushfittings
code	KMP447X



Art. No	label	d2	d1 mm	d3 mm	L1 mm	L2 mm	L3 mm	z1 mm	z2 mm	z3 mm	slw1 mm
730240F	32x1/2"	1/2" (15)	32	32	60,5	39	60,5	21,5	22,5	21,5	30