

KELOX

KMP485SBX KELOX-PROTEC CLIX connection set with siphon elbow 20x1/2" 8-10cm

730264D02

Areas of application

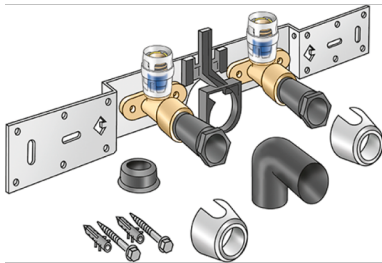

With KMP480X wall bracket fitting, sound-insulated; stopper, metal mount, plugs and fastening elements, incl. elbow for connecting to trap d50mm and galvanised nipple d30
DO NOT screw in any threaded pipes and cast iron fittings!

Approvals:



KE KELIT GmbH

A 4020 Linz, Ignaz-Mayer-Straße 17, Austria, Europe

PHONE +43 (0) 50 779 E-MAIL office@kekelit.com

www.kekelit.com

Specifications

Article information

port 1 Einsteck (Push-Fitting)

Product information

VPE1 1,00 KT1

VPE2 15,00 KT2

weight 1,086 KGM

text KELOX-PROTEC CLIX connection set with siphon elbow

INTRNR 74122000

main material group KELOX

material group KELOX-PROtec pushfittings

code KMP485SBX

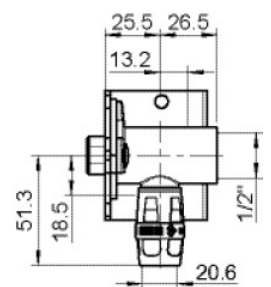
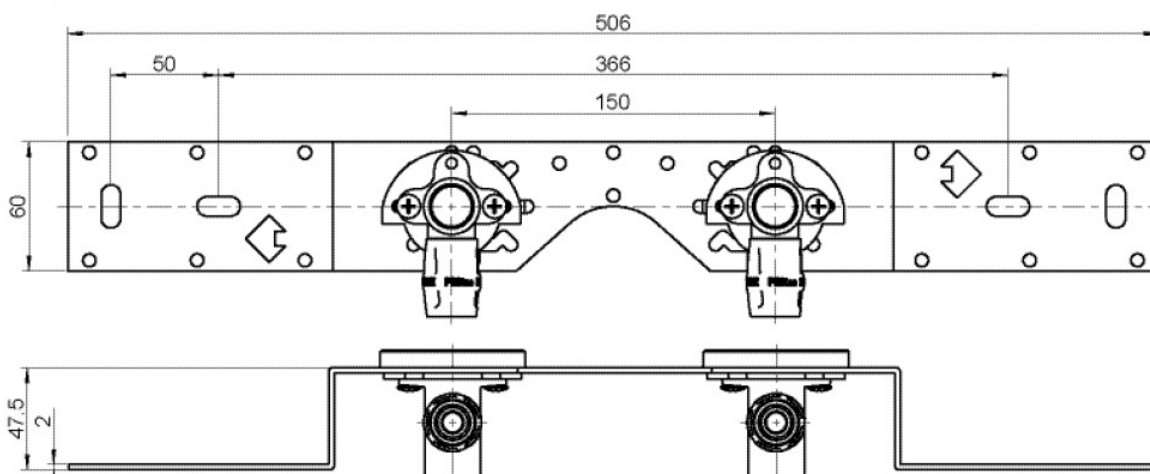
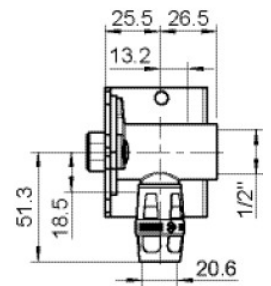
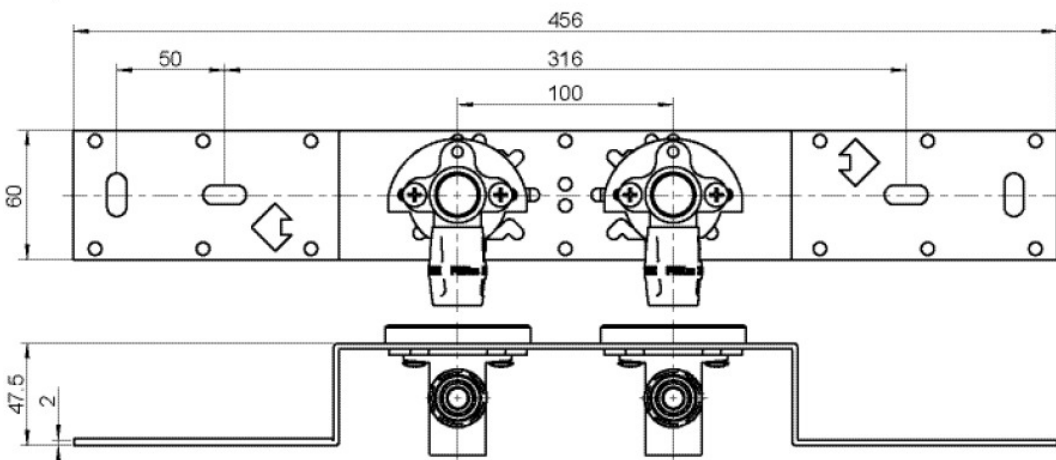
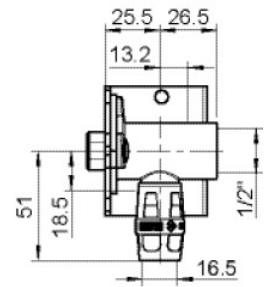
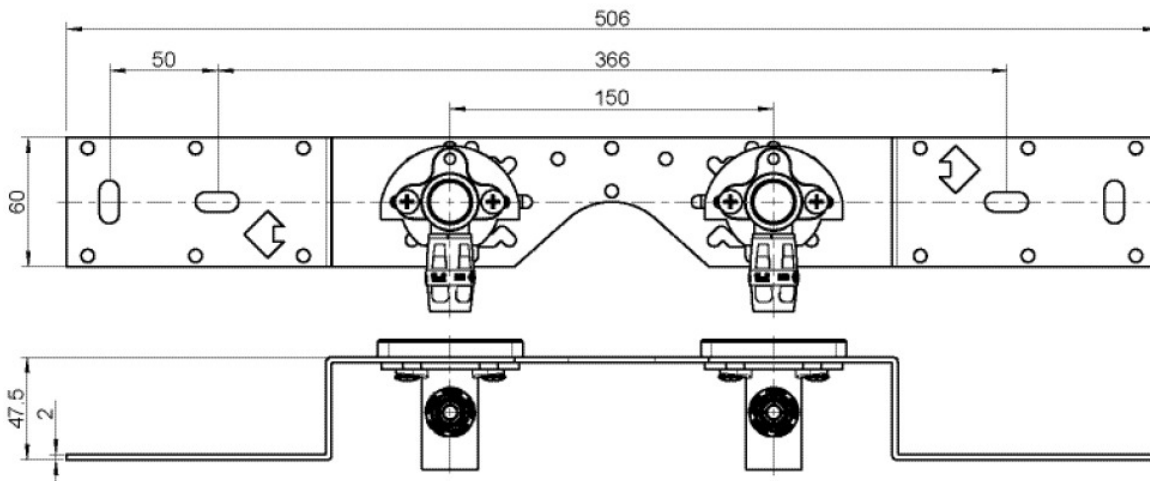
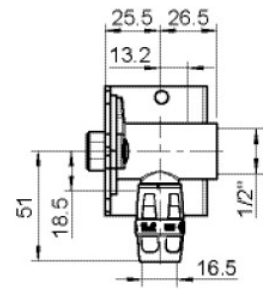
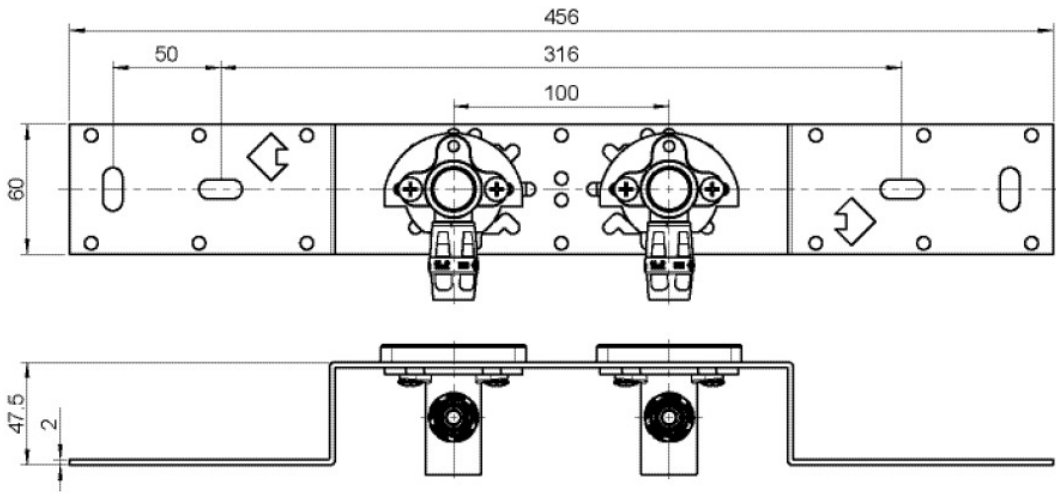

KE KELIT GmbH

A 4020 Linz, Ignaz-Mayer-Straße 17, Austria, Europe

PHONE +43 (0) 50 779 E-MAIL office@kekelit.com

www.kekelit.com

Art. No	label
730264D02	20x1/2" 8-10cm



KE KELIT GmbH
A 4020 Linz, Ignaz-Mayer-Straße 17, Austria, Europe
PHONE +43 (0) 50 779 **E-MAIL** office@kekelit.com
www.kekelit.com