

# KELOX

## KMP485SBX KELOX-PROTEC CLIX connection set with siphon elbow 20x1/2" 15cm

730268D02

### Areas of application

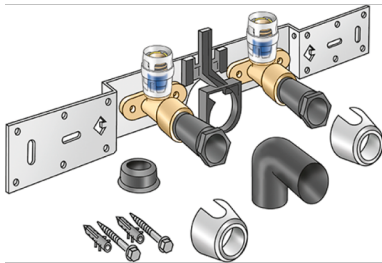

With KMP480X wall bracket fitting, sound-insulated; stopper, metal mount, plugs and fastening elements, incl. elbow for connecting to trap d50mm and galvanised nipple d30  
DO NOT screw in any threaded pipes and cast iron fittings!

### Approvals:



KE KELIT GmbH

A 4020 Linz, Ignaz-Mayer-Straße 17, Austria, Europe

PHONE +43 (0) 50 779 E-MAIL [office@kekelit.com](mailto:office@kekelit.com)

[www.kekelit.com](http://www.kekelit.com)

# Specifications

## Article information

**port 1** Einsteck (Push-Fitting)

## Product information

**VPE1** 1,00 KT1

**VPE2** 15,00 KT2

**weight** 1,112 KGM

**text** KELOX-PROTEC CLIX connection set with siphon elbow

**INTRNR** 74122000

**main material group** KELOX

**material group** KELOX-PROtec pushfittings

**code** KMP485SBX

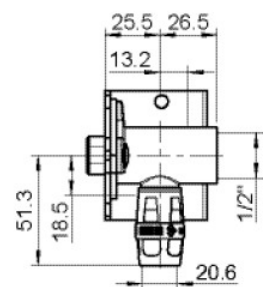
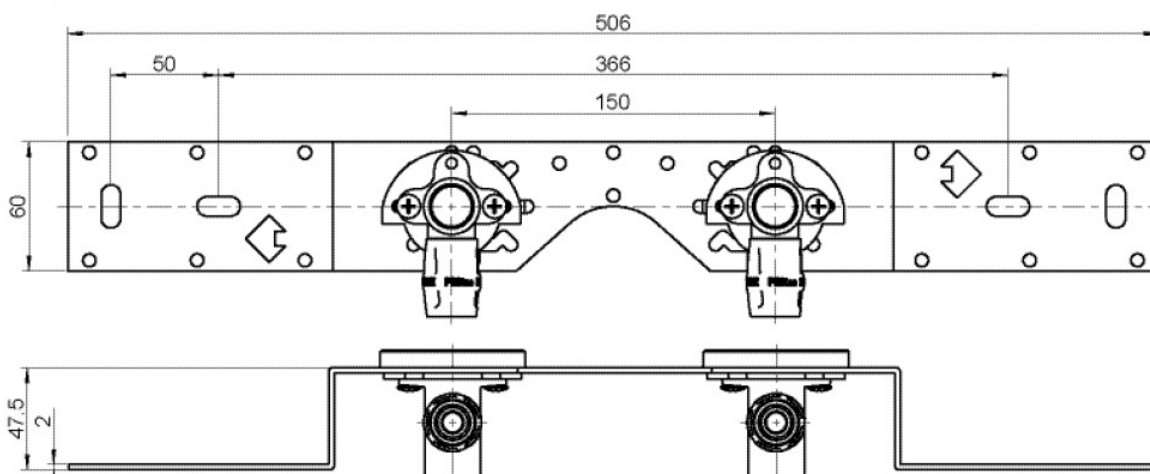
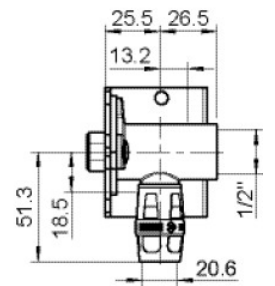
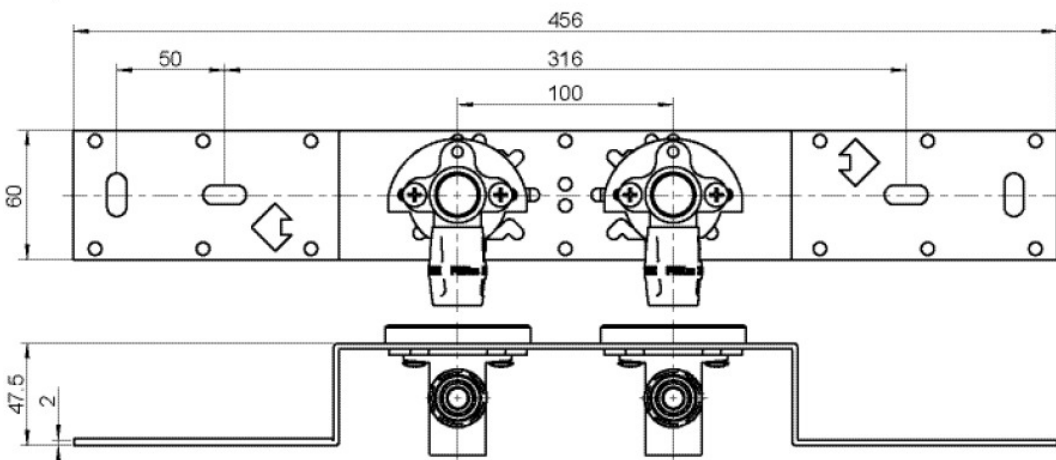
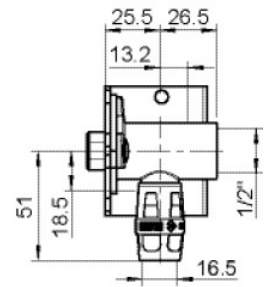
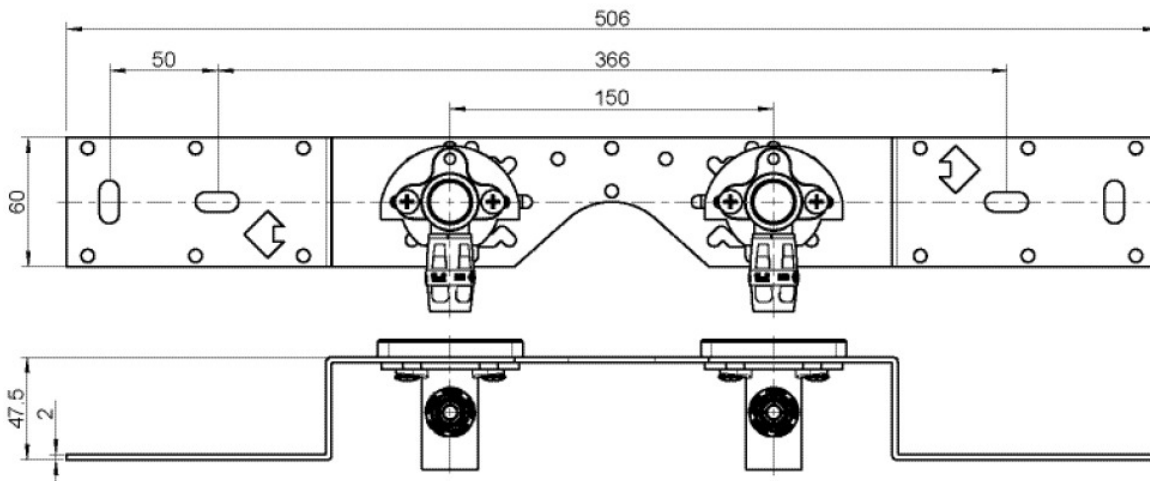
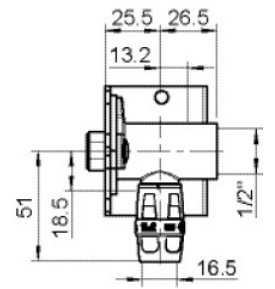
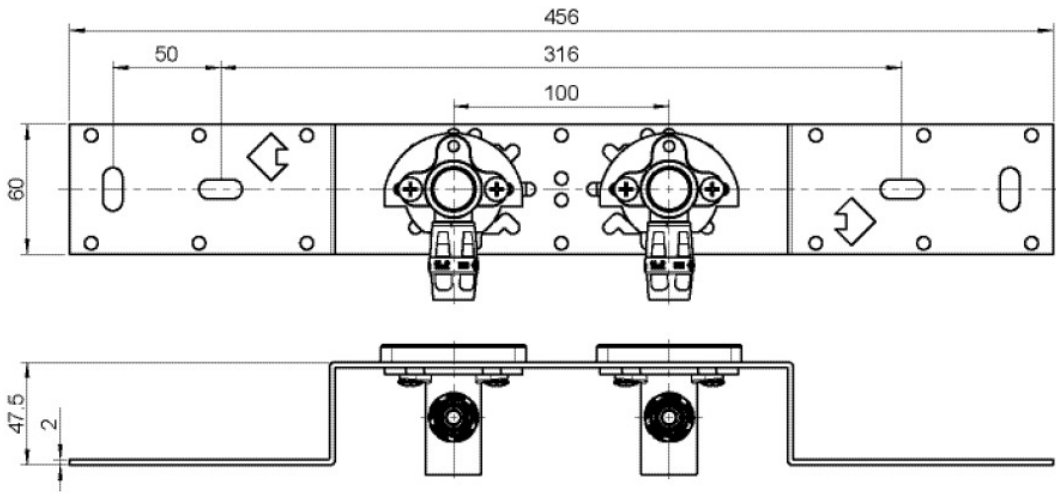

**KE KELIT GmbH**

A 4020 Linz, Ignaz-Mayer-Straße 17, Austria, Europe

PHONE +43 (0) 50 779 E-MAIL office@kekelit.com

www.kekelit.com

Art. No	label
730268D02	20x1/2" 15cm



**KE KELIT GmbH**  
A 4020 Linz, Ignaz-Mayer-Straße 17, Austria, Europe  
**PHONE** +43 (0) 50 779 **E-MAIL** office@kekelit.com  
www.kekelit.com