

# STEELOX

## SMX451 STEELOX Holländer mit AG 16x3/4"

57241B04

### Areas of application

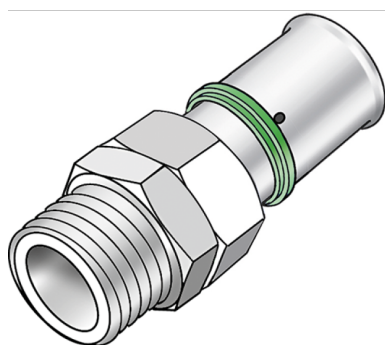

Variationsgruppentext: STEELOX Press-Holländer mit AG aus Edelstahl, Gewinde gemäß ÖNORM EN 10226,

zum Anschluss an Armaturen, aus enzinkungsdeständigem Messing (DZR), inkl. Stützhülsen mit O-Ringen und Edelstahl-Presshülsen, "unverpresst undicht", flach dichtend inkl. Dichtung

### Approvals:



KE KELIT GmbH

A 4020 Linz, Ignaz-Mayer-Straße 17, Austria, Europe

PHONE +43 (0) 50 779 E-MAIL [office@kekelit.com](mailto:office@kekelit.com)

[www.kekelit.com](http://www.kekelit.com)

# Specifications

## Article information

port 1	Pressmuffe
port 2	Außengewinde konisch (NPT)
execution	2-teilig
design	straight
press contour	U

## Technical properties

maximum working pressure at 20 ° C	10 bar
------------------------------------	--------

## Product information

VPE1	10,00 SA1
VPE2	200,00 KT1
weight	0,077 KGM
text	STEELOX Holländer mit AG
INTRNR	74122000
code	SMX451

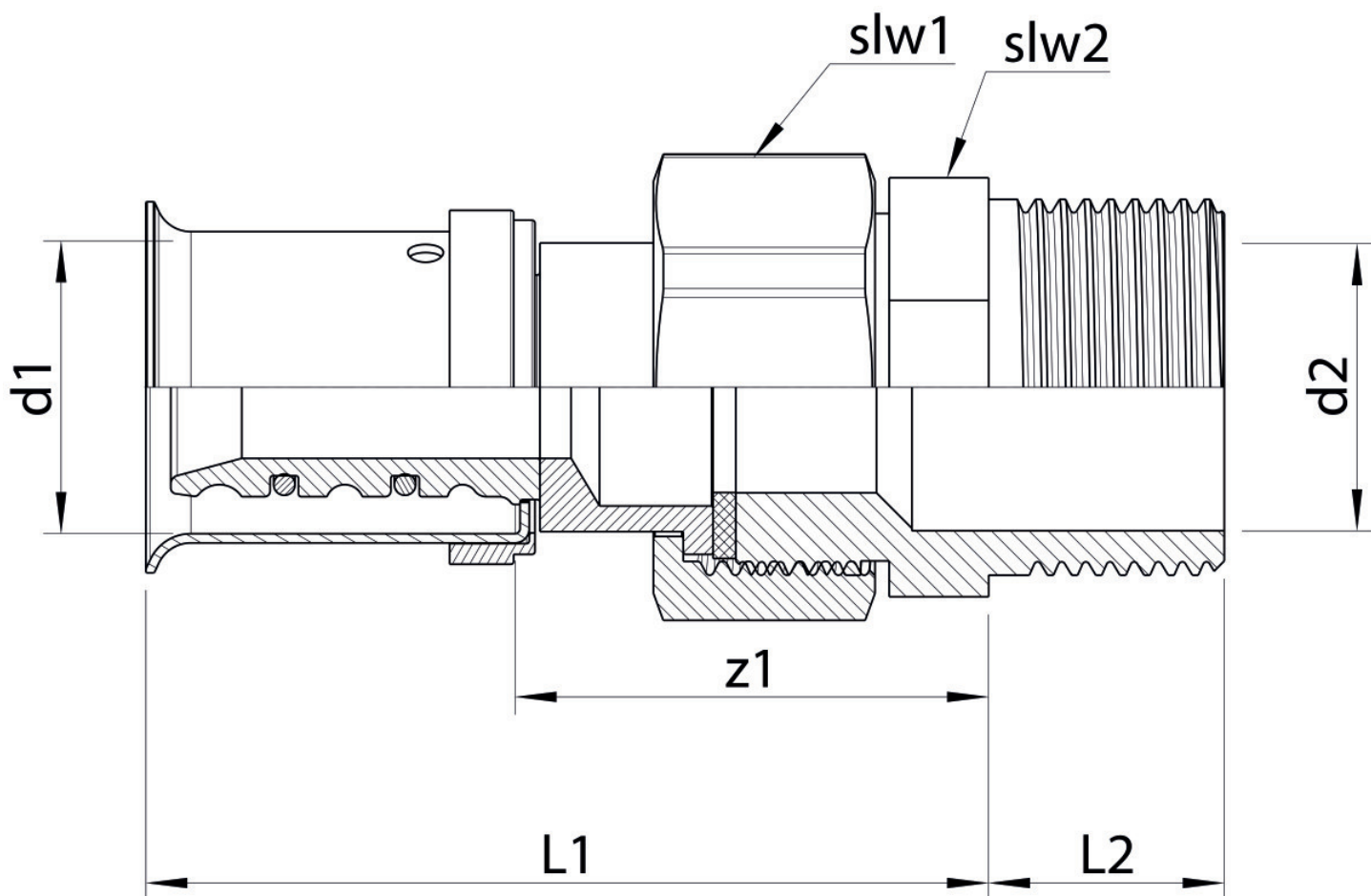

Art. No	label	d2	d1 mm	L1 mm	L2 mm	z1 mm	slw1 mm	slw2 mm
57241B04	16x3/4"	3/4 Zoll (20)	16	57	17	34	30	30