

# CF1000 STEELFIX-CX carbon steel pipe 54x1.5

3000130

## Areas of application

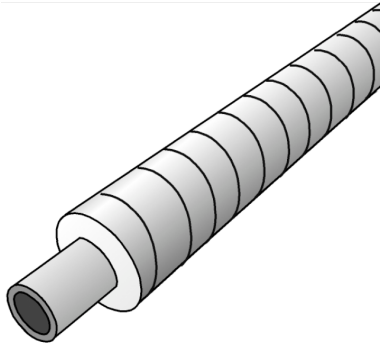

Pre-insulated carbon steel piping system

Medium pipe: Thin-walled, longitudinally welded stainless steel pipes according to EN 10305-3 with a particularly low carbon content and with the outside protected by a thermally applied zinc layer and a passivating/chromium layer

Area of application: closed heating and cooling circuits

Operating temperature: - 35°C to 120°C/16 bar - tmax 150°C - short-term

Insulation: PUR rigid foam, jacket pipe: 0.6 mm galvanised folded spiral sheet metal

Length: 6m

# Specifications

Product information	
<b>casing DA</b>	125
<b>VPE1</b>	6,00 STG
<b>L</b>	6 m
<b>weight</b>	5,010 KGM
<b>text</b>	STEELFIX-CX carbon steel pipe
<b>INTRNR</b>	73065080
<b>main material group</b>	STEELFIX CX/PE
<b>material group</b>	STEELFIX CX/PE C-Stahl pipes and fittings
<b>code</b>	CF1000

Art. No	label
3000130	54x1.5