

CP2020 STEELFIX-PE carbon steel elbow 88.9x2.0

3000640

Areas of application

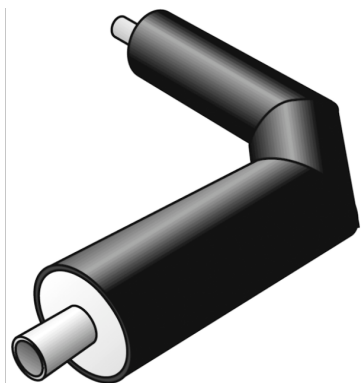

Pre-insulated carbon steel 90° elbow

Medium pipe: Thin-walled, longitudinally welded stainless steel pipes according to EN 10305-3 with a particularly low carbon content and with the outside protected by a thermally applied zinc layer and a passivating/chromium layer

Area of application: closed heating and cooling circuits

Insulation: PUR hard foam, jacket pipe: PE-HD

also available in 45°!

Leg length: 500 x 500mm, other leg lengths on request!

Specifications

Product information	
casing DA	160
VPE1	1,00 STK
weight	9,110 KGM
text	STEELFIX-PE carbon steel elbow
INTRNR	73071190
main material group	STEELFIX CX/PE
material group	STEELFIX CX/PE C-Stahl pipes and fittings
code	CP2020

Art. No	label
3000640	88.9x2.0