

# NP2020 STEELFIX-PE stainless steel elbow 1.4401 28x1.2

3000665

## Areas of application

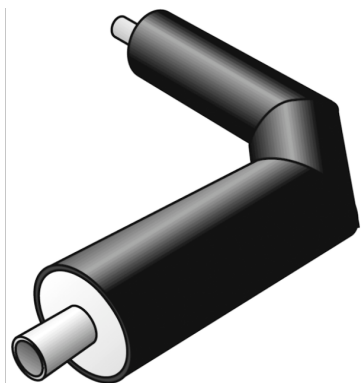

Pre-insulated stainless steel 90° elbow

Medium pipe: Thin-walled, longitudinally welded stainless steel pipes 1.4401 according to EN 10312 and EN 10217-7 outside and inside bare metallic

Application area: Drinking water installations, service water and rain water, compressed air

Insulation: PUR hard foam, jacket pipe: PE-HD

also available in 45°!

Leg length: 500 x 500mm, other leg lengths on request!

## Approvals:



# Specifications

Product information	
casing DA	90
VPE1	1,00 STK
weight	1,960 KGM
text	STEELFIX-PE stainless steel elbow 1.4401
INTRNR	73071990
main material group	STEELFIX CX/PE
material group	STEELFIX CX/PE stainless steel pipes and fittings
code	NP2020

Art. No	label
3000665	28x1.2