

KELEN

KE08 KELEN PP-RCT pipe - PN16 25x3,5

1682501

Areas of application

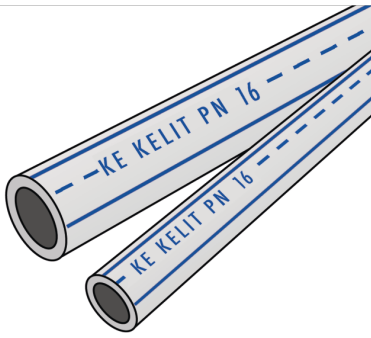

KELEN PP-RCT drinking water pipe system conforming to ÖNORM EN ISO 15874 made of polypropylene (PP-RCT)

Application area: 20°C/16 bar - 70°C/10 bar

Colour: grey and 3 co-extruded longitudinal blue lines

Length: 4m

Approvals:



KE KELIT GmbH

A 4020 Linz, Ignaz-Mayer-Straße 17, Austria, Europe

PHONE +43 (0) 50 779 E-MAIL office@kekelit.com

www.kekelit.com

Specifications

Article information

port 1	Rohrende
port 2	Rohrende
color	grau

Technical properties

pipe weight	0,23 kg/m
pipe contents	0,25 l/m
PN	PN 16
lambda pipe	0,24 W/(m.K)
wall rawness	0,007 mm
expansion coefficient	0,15 mm/(m.K)

Product information

DIM2	18,0
VPE1	40 BND
VPE2	4000 HOB
L	4 m
weight	0,23 KGM
text	KELEN PP-RCT pipe - PN16
INTRNR	39172290
main material group	KELEN
material group	KELEN pipes
code	KE08

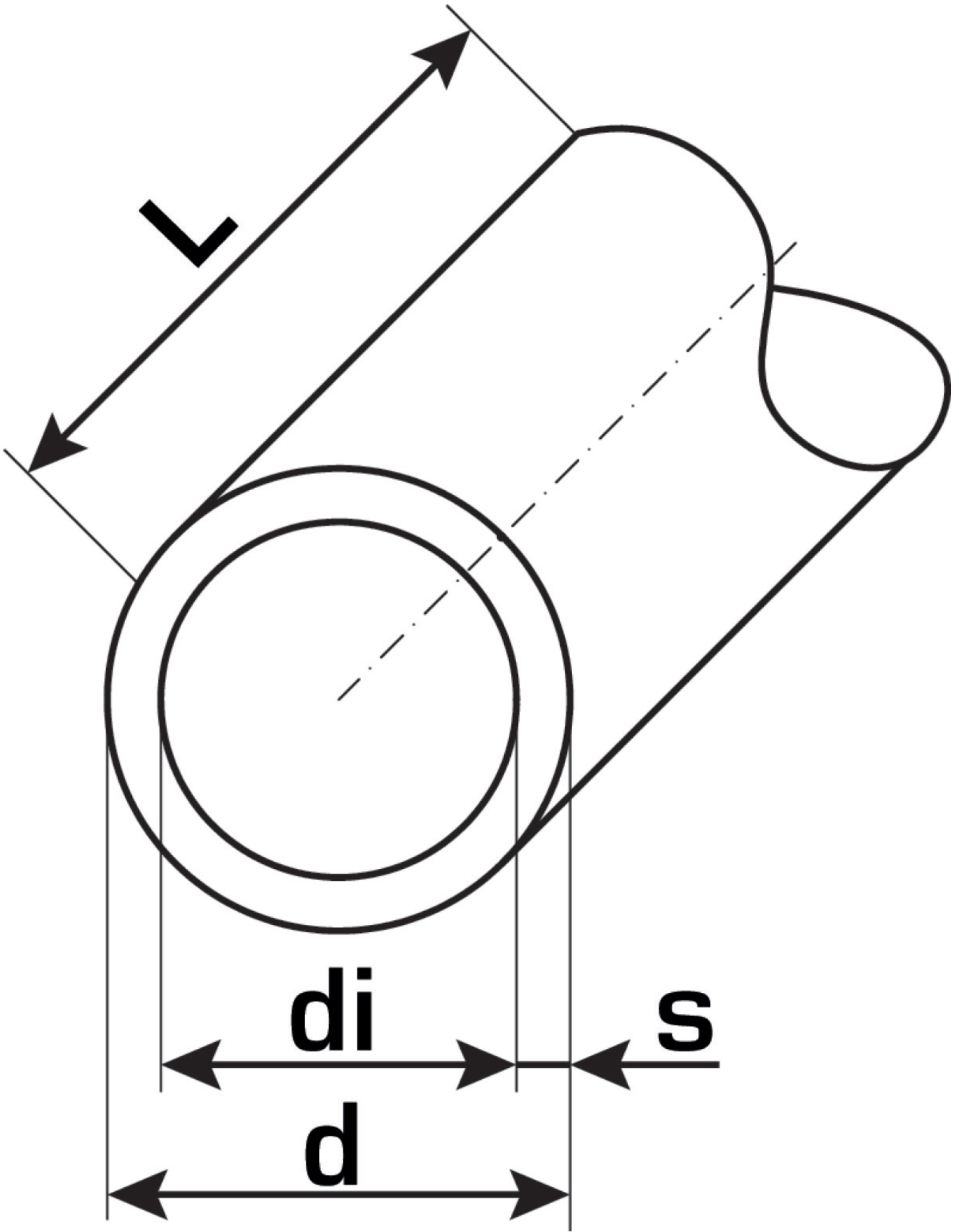

Art. No	label	d1 mm	pipe contents l/m	s mm
1682501	25x3,5	25	0,25	3,5



KE KELIT GmbH

A 4020 Linz, Ignaz-Mayer-Straße 17, Austria, Europe

PHONE +43 (0) 50 779 **E-MAIL** office@kekelit.com

www.kekelit.com