

KELEN

KE00-LX4 KELEN PP-RCT LX-SENSO pipe - PN20 32x5,4

1532041

Areas of application

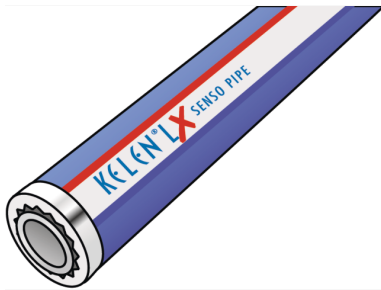

KELEN PP-RCT SENSO drinking water pipe system conforming to ÖNORM EN ISO 15874 made of polypropylene (PP-RCT) with factory-installed 4mm soft-foam insulation, can be located electronically; outer layer consisting of woven tape fabric and viscoplastic polymer alloy

Application area: 20°C/20 bar - 70°C/10 bar

Length: 4m

Approvals:



Specifications

Article information

port 1	Rohrende
port 2	Rohrende
color	grau

Technical properties

isolation thickness	4 mm
pipe weight	0,46 kg/m
pipe contents	0,35 l/m
thermal conductivity	0,039 W/(m.K)
diameter inner tube	32 mm
PN	PN 16
wall rawness	0,007 mm
expansion coefficient	0,15 mm/(m.K)

Product information

DIM2	21,2
VPE1	40 BND
VPE2	2000 HOB
L	4 m
weight	0,46 KGM
text	KELEN PP-RCT LX-SENSO pipe - PN20
INTRNR	39172290
main material group	KELEN
material group	KELEN-LX pipes
code	KE00-LX4

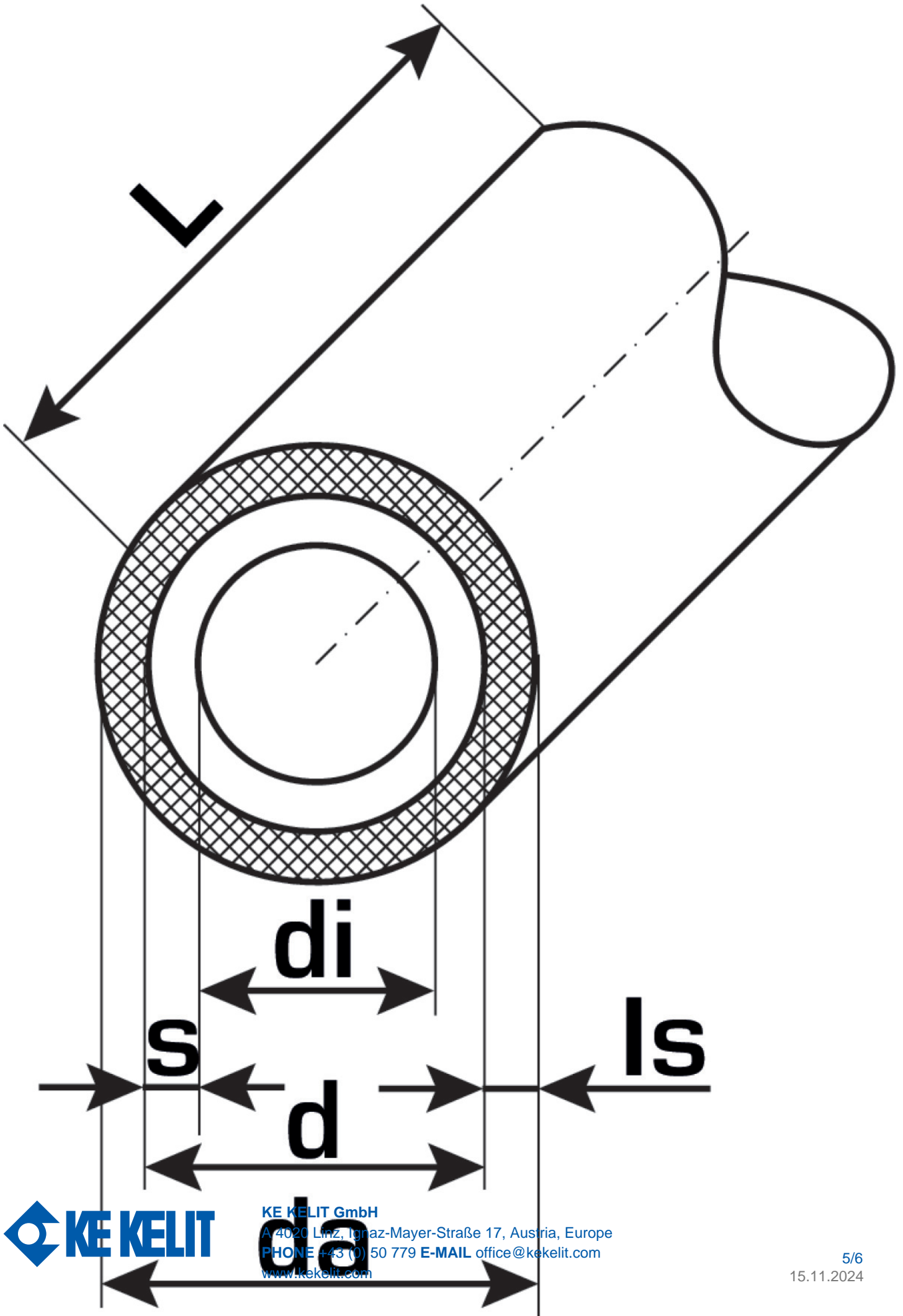

Art. No	label	d mm	d mm	d1 mm	pipe contents l/m	s mm
1532041	32x5,4	21,2	21,2	32	0,35	5,4



KE KELIT GmbH

A 4020 Linz, Ignaz-Mayer-Straße 17, Austria, Europe

PHONE +43 (0) 50 779 **E-MAIL** office@kekelit.com

www.kekelit.com