

KELEN

KE43 KELEN saddle fitting female 63-125x1/2"

2475051

Areas of application

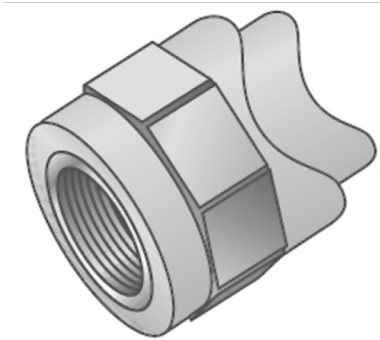

KELEN polyfusion weld fitting for connecting pipes with fittings made of the same material without narrowing the cross-section, injected female thread made of dezincification-resistant non-porous metallised brass, threads conform to DIN EN 10226. For welding directly to pipelines that have already been installed; the welding is carried out with a WZ124 saddle welding tool
Do NOT connect to threaded pipes or to cast iron fittings!

Approvals:



KE KELIT GmbH

A 4020 Linz, Ignaz-Mayer-Straße 17, Austria, Europe

PHONE +43 (0) 50 779 E-MAIL office@kekelit.com

www.kekelit.com

Specifications

Product information	
VPE1	5,00 SA1
VPE2	80,00 KT1
VPE3	320,00 KT2
VPE4	7680,00 PAL
weight	0,069 KGM
text	KELEN saddle fitting female
INTRNR	39174000
main material group	KELEN
material group	KELEN metal fittings
code	KE43



Art. No	label	d	L2 mm	z1 mm
2475051	63-125x1/2"	1/2" (15)	15	13