

KELEN

KE50 KELEN PP-RCT shut-off valve with stem 25x3/4"

2660301

Areas of application

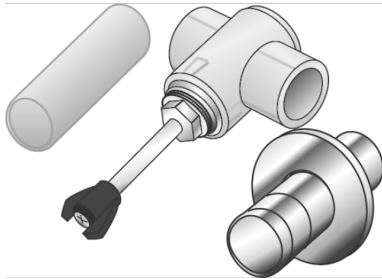

KELEN PP-RCT Polyfusion welding fitting for connecting pipes with fittings made of the same material (no reduction of internal diameter), service valve with metal seating, incl. chrome-plated end cap, rosette and protection cap.

Approvals:



KE KELIT GmbH

A 4020 Linz, Ignaz-Mayer-Straße 17, Austria, Europe

PHONE +43 (0) 50 779 E-MAIL office@kekelit.com

www.kekelit.com

Specifications

Article information

port 1	Kunststoffschweißmuffe
port 2	Innengewinde
port 3	Kunststoffschweißmuffe
execution	T-Stück
angle	90 °

Product information

VPE1	1 SA1
VPE2	15 KT1
VPE3	60 KT2
VPE4	1440 PAL
weight	0,38 KGM
text	KELEN PP-RCT shut-off valve with stem
INTRNR	39174000
main material group	KELEN
material group	KELEN metal fittings
code	KE50

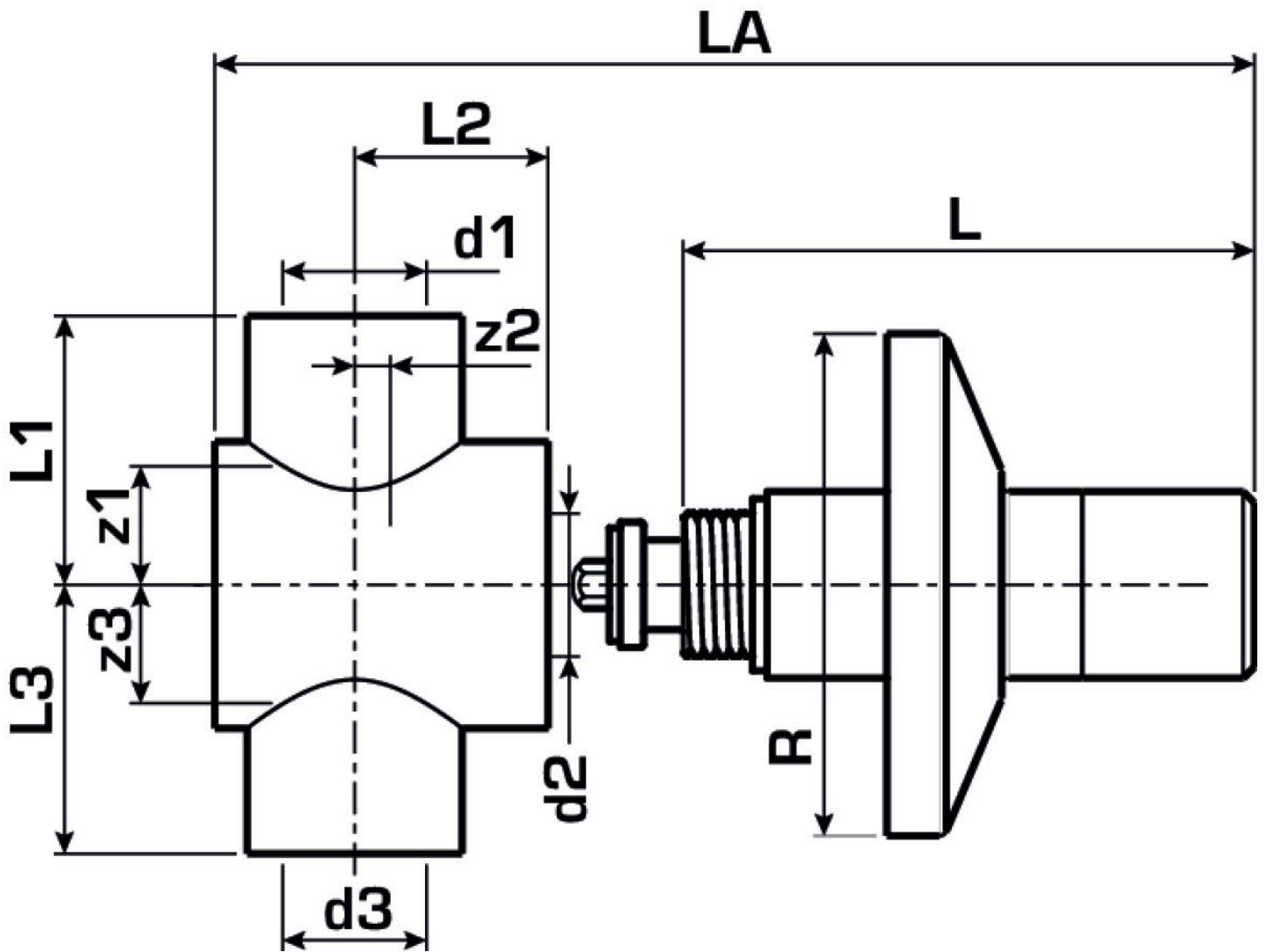

Art. No	label	d1 mm	d2 Zoll	d3 mm	d1 mm	L1 mm	L1 mm	L2 mm	L3 mm	L1 / L3 mm	z1 mm	z2 mm	z3 mm	z2 mm
26603C	25x3/4	25	3/4"	25	25	130	43	114	43	44	23	17	23	4