

KELEN

KE52 KELEN PP-RCT slanted seat valve with fitting connection KE57 25-DN20

2670251

Areas of application

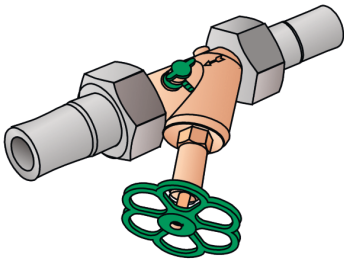

KELEN PP-RCT Polyfusion welding fitting, with fitting screw connections KE57 flat sealing, top part "dead space-free", incl. EPDM seal and outflow plastic socket or EPDM seal available separately!

Approvals:



Specifications

Product information	
VPE1	1 SA1
VPE2	10 KT1
VPE3	40 KT2
VPE4	960 PAL
weight	0,85 KGM
text	KELEN PP-RCT slanted seat valve with fitting connection KE57
INTRNR	84818079
main material group	KELEN
material group	KELEN metal fittings
code	KE52

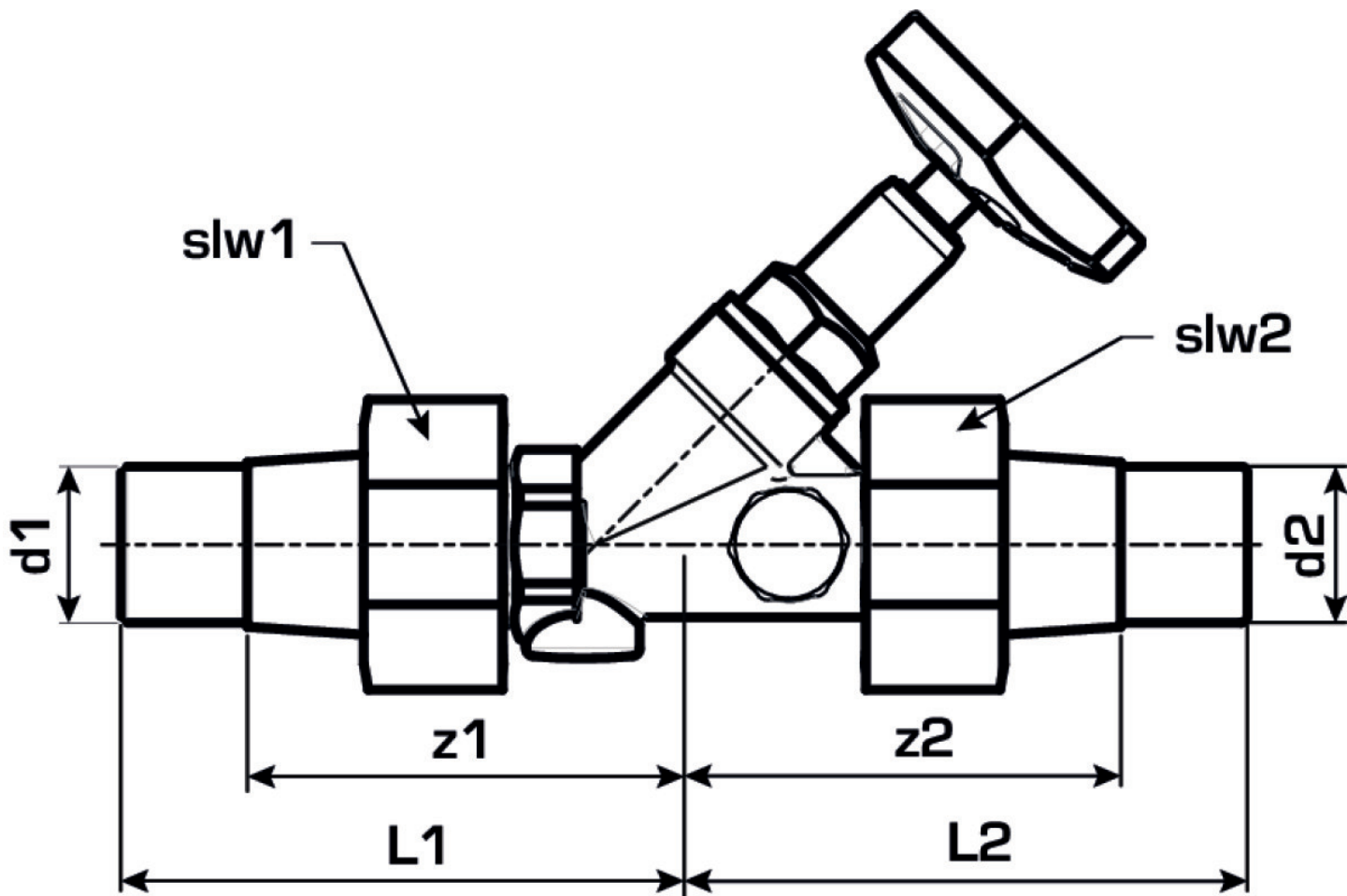

Art. No	label	L1 mm	L2 mm	z1 mm	z2 mm	slw1	slw2
2670251	25-DN20	95	95	75	75	46	46