

KELOX

KM441 KELOX double connector tee 20/16/20

9848220

Areas of application

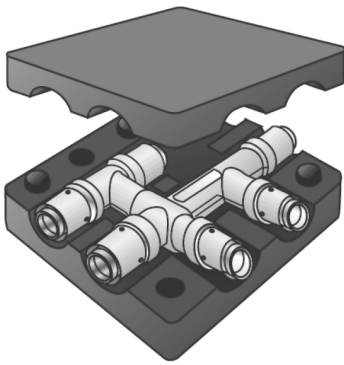

Double press tee piece equal or reduced in noise protection box, made from non-porous metallized brass, including support sleeves with O-rings and stainless steel press-fit sleeves

Size: L: 115mm, W: 115mm, H: 55mm

Approvals:



Specifications

Article information

port 1	Pressing socket
port 2	Pressing socket
execution	Cross pair
press contour	U

Product information

VPE1	1 KT1
weight	0,4 KGM
text	KELOX double connector tee
INTRNR	74122000
main material group	KELOX
material group	KELOX metal fittings
code	KM441

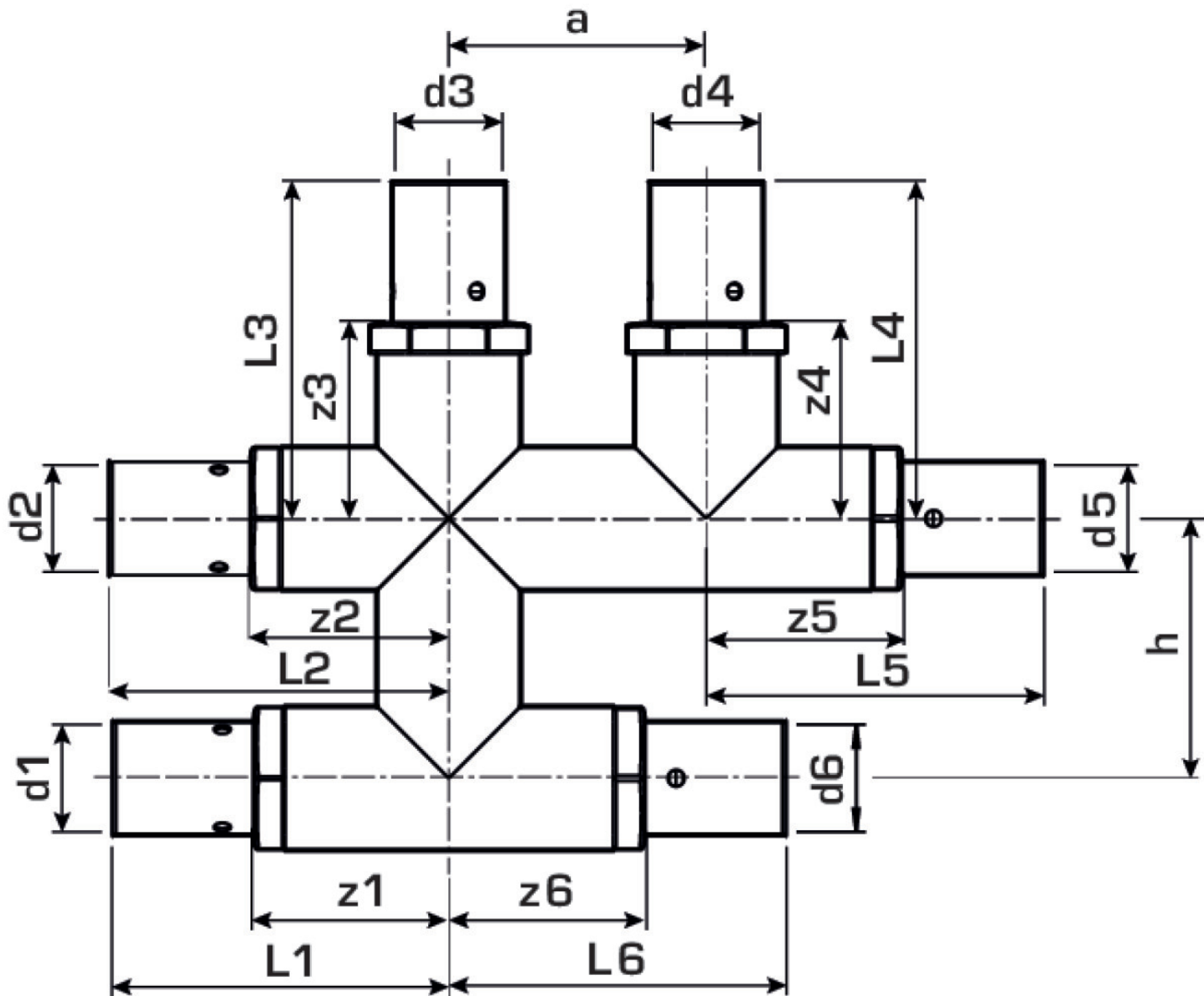

Art. No

label

9848220

20/16/20