

KELOX

KM258 KELOX stopper for pressure testing O-Ring 16

7604161

Areas of application

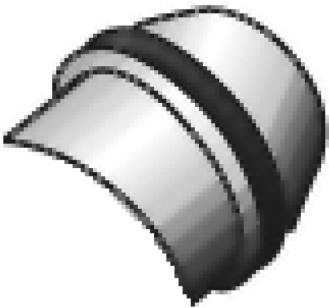

Re-usable plug for pressure testing KELOX multilayer pipes

After removing the plug, cut off the pipe end!

NOT suitable for continuous use!

Specifications

Technical properties

maximum working pressure at 20 ° C	10
------------------------------------	----

Product information

VPE1	10 SA1
VPE2	2000 KT1
weight	0,001 KGM
text	KELOX stopper for pressure testing
INTRNR	74122000
main material group	KELOX
material group	KELOX accessories
code	KM258

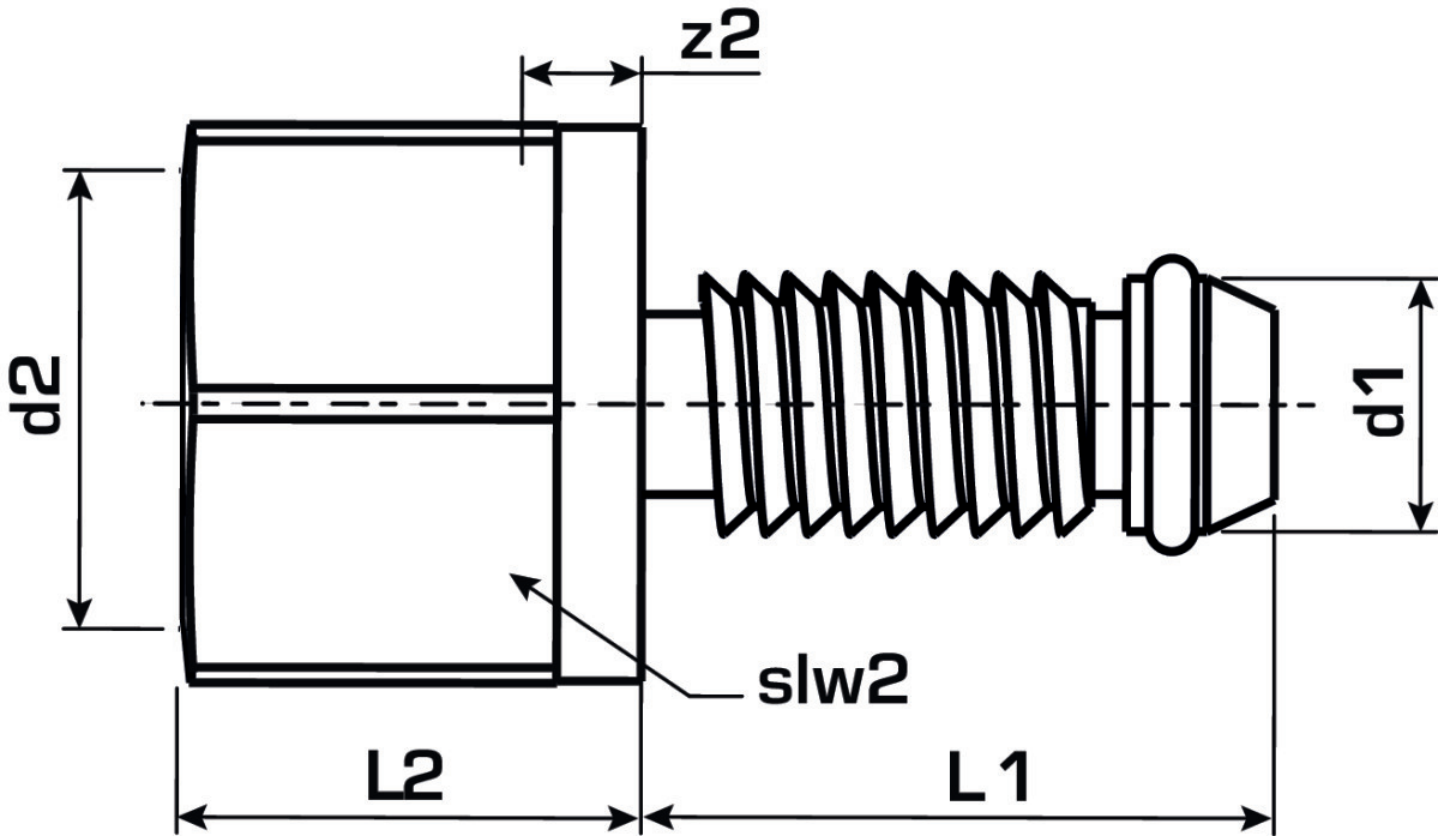

Art. No	label
7604161	O-Ring 16