

KELOX

KM258 KELOX stopper for pressure testing O-Ring 25

7604251

Areas of application

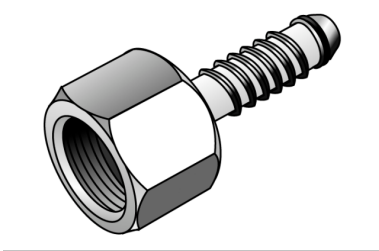

Re-usable plug for forcing off KELOX multilayer pipes

After removing the forcing-off plug, cut off the pipe end!

NOT suitable for continuous use!

Specifications

Technical properties

maximum working pressure at 20 ° C	10
------------------------------------	----

Product information

VPE1	10,00 SA1
VPE2	800,00 KT1
weight	0,003 KGM
text	KELOX stopper for pressure testing
INTRNR	40169300
main material group	KELOX
material group	KELOX accessories
code	KM258

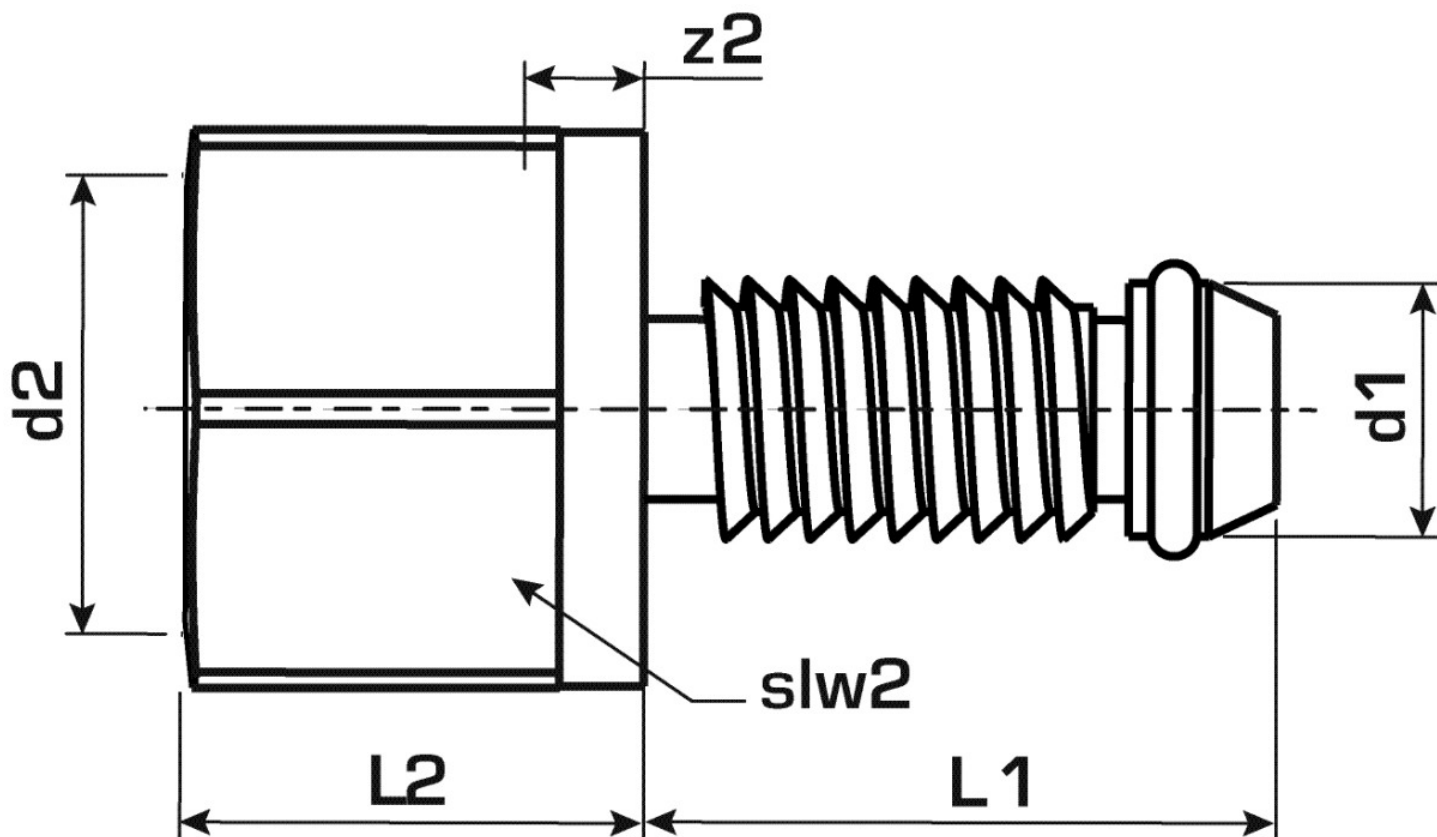

Art. No

label

7604251

O-Ring 25