

# KELOX

## KM258 KELOX stopper for pressure testing O-Ring 40

7604401

### Areas of application

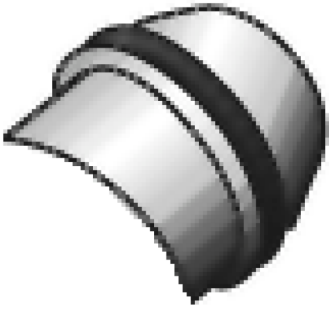

Re-usable plug for pressure testing KELOX multilayer pipes

After removing the plug, cut off the pipe end!

NOT suitable for continuous use!

# Specifications

## Technical properties

maximum working pressure at 20 ° C	10
------------------------------------	----

## Product information

VPE1	10 SA1
VPE2	300 KT1
weight	0,003 KGM
text	KELOX stopper for pressure testing
INTRNR	74122000
main material group	KELOX
material group	KELOX accessories
code	KM258

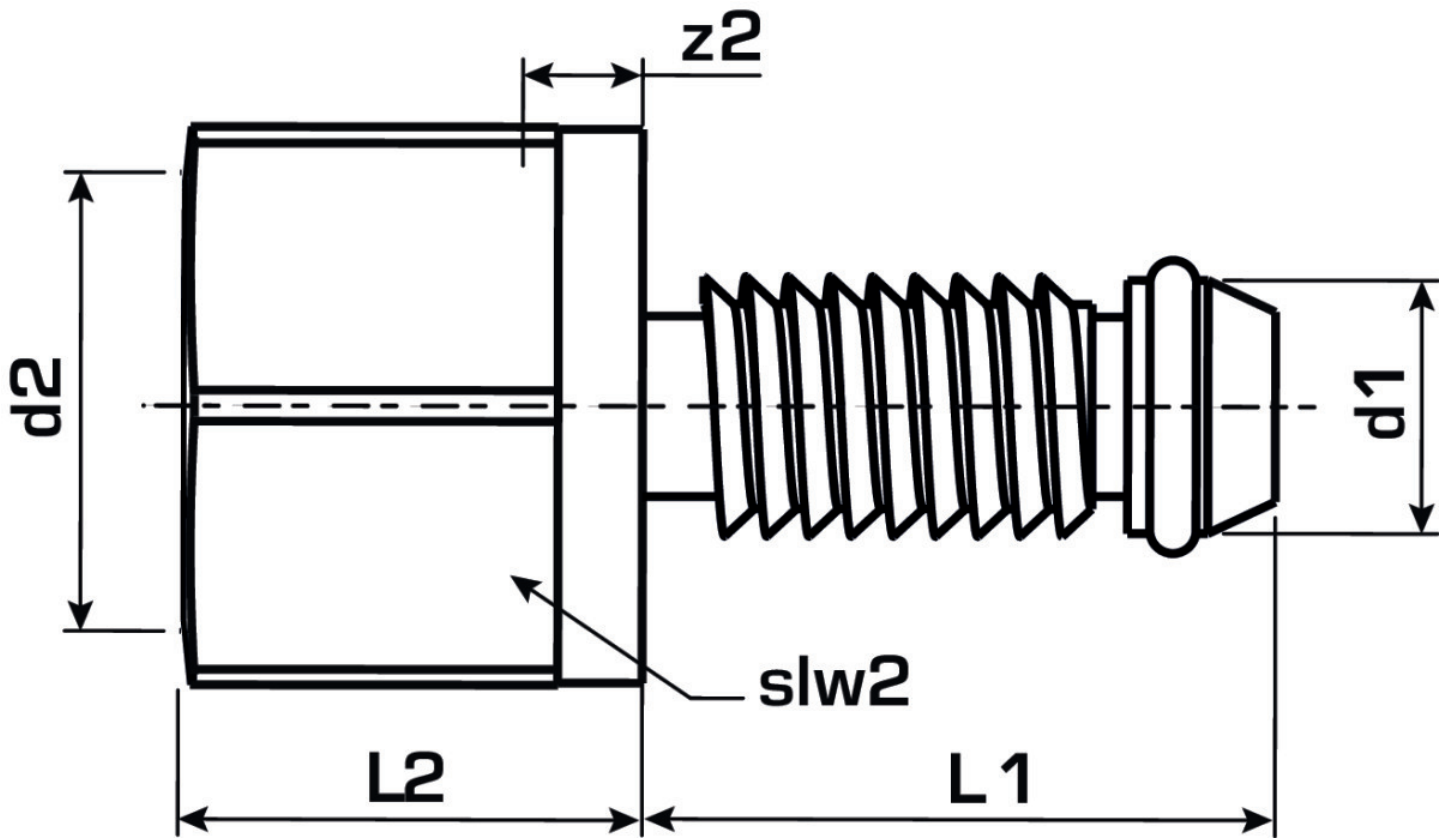

Art. No	label
7604401	O-Ring 40