

KELOX

KM580E KELOX radiator & sanitary manifold 8 L: 425mm

7808500

Areas of application

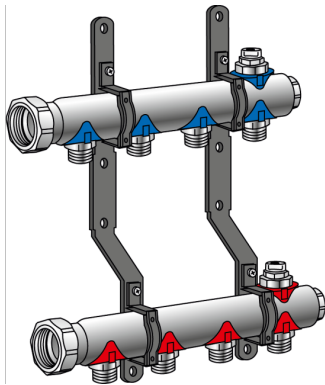

?Feed and return flow bars with heating circuit outlets 3/4" euro cone with male thread, with bleeding at the highest point and draining, manifold ends closed, connections with pre-formed union nut 1" flat-sealing, non-porous metallised brass, incl. labelled plates for each heating circuit and sound-insulated plastic consoles

Area of application: tmax. 90°C/10 bar

ATTENTION: WITHOUT KM220 Euro thread fitting!

Approvals:



Specifications

| Product information | |
|---------------------|------------------------------------|
| VPE1 | 1,00 KT1 |
| weight | 2,775 KGM |
| text | KELOX radiator & sanitary manifold |
| INTRNR | 84818039 |
| main material group | KELOX |
| material group | KELOX accessories |
| code | KM580E |

| Art. No | label |
|---------|------------|
| 7808500 | 8 L: 425mm |