

KELOX

KM260 KELOX screw fitting with female thread for pressure testing 75x1/2"

7624750

Areas of application

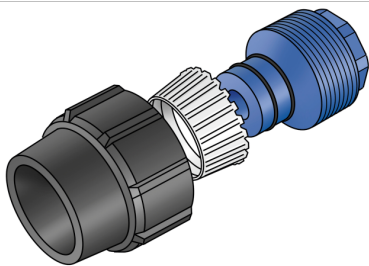

Re-usable screw fitting with female thread for pressure testing KELOX multilayer pipes

After removing the forcing-off screw fitting, cut off the pipe end!

If worn, replace the forcing-off screw fitting!

NOT suitable for continuous use!

Specifications

Article information

port 1	Klemmring
port 2	Innengewinde zylindrisch BSPT-Rp (ISO 7-1 / EN 10226-1)
execution	3-teilig
design	gerade

Product information

VPE1	1,00 SA1
VPE2	4,00 KT1
weight	1,050 KGM
text	KELOX screw fitting with female thread for pressure testing
INTRNR	74122000
main material group	KELOX
material group	KELOX accessories
code	KM260

Art. No	label	d2	d1 mm	L1 mm	L2 mm	z2 mm	slw2 mm
7624750	75x1/2"	1/2" (15)	75	45	53	14	85