

KELOX

KM260 KELOX screw fitting with female thread for pressure testing O-Ring 63

7624631

Areas of application

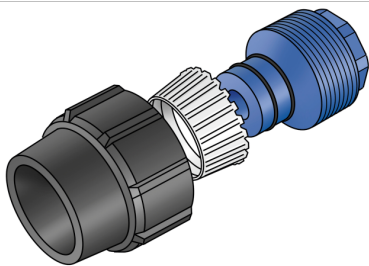

Re-usable screw fitting with female thread for pressure testing KELOX multilayer pipes

After removing the forcing-off screw fitting, cut off the pipe end!

If worn, replace the forcing-off screw fitting!

NOT suitable for continuous use!

Specifications

Product information	
VPE1	10,00 SA1
VPE2	300,00 KT1
weight	0,002 KGM
text	KELOX screw fitting with female thread for pressure testing
INTRNR	74122000
main material group	KELOX
material group	KELOX accessories
code	KM260

Art. No	label
7624631	O-Ring 63



KE KELIT GmbH
A 4020 Linz, Ignaz-Mayer-Straße 17, Austria, Europe
PHONE +43 (0) 50 779 **E-MAIL** office@kekelit.com
www.kekelit.com