

KELOX

KMU430 KELOX-ULTRAX radiator elbow 90° 16/15/150

71150B39

Areas of application



?Radiator connecting pipe made of semi-rigid nickel-plated d12 or d15mm copper with 90° press-fit adapter elbow made from non-porous metallised brass, incl. support sleeves with O-rings and stainless steel press-fit sleeves; "leak before pressed"

ATTENTION: Follow the installation instructions of the screw fitting manufacturer and if necessary use support sleeves for copper connections!

Approvals:



Specifications

Article information

port 1	Pressmuffe
port 2	Zapfen/Rohrende
execution	1-part
design	Winkel
angle	90 °
press contour	U

Technical properties

maximum working pressure at 20 ° C	16 bar
------------------------------------	--------

Product information

VPE1	1,00 SA1
VPE2	40,00 KT1
weight	0,096 KGM
text	KELOX-ULTRAX radiator elbow 90°
INTRNR	74122000
main material group	KELOX
material group	KELOX-ULTRAX metal fittings
code	KMU430

L2

z2

L1

z1

d1

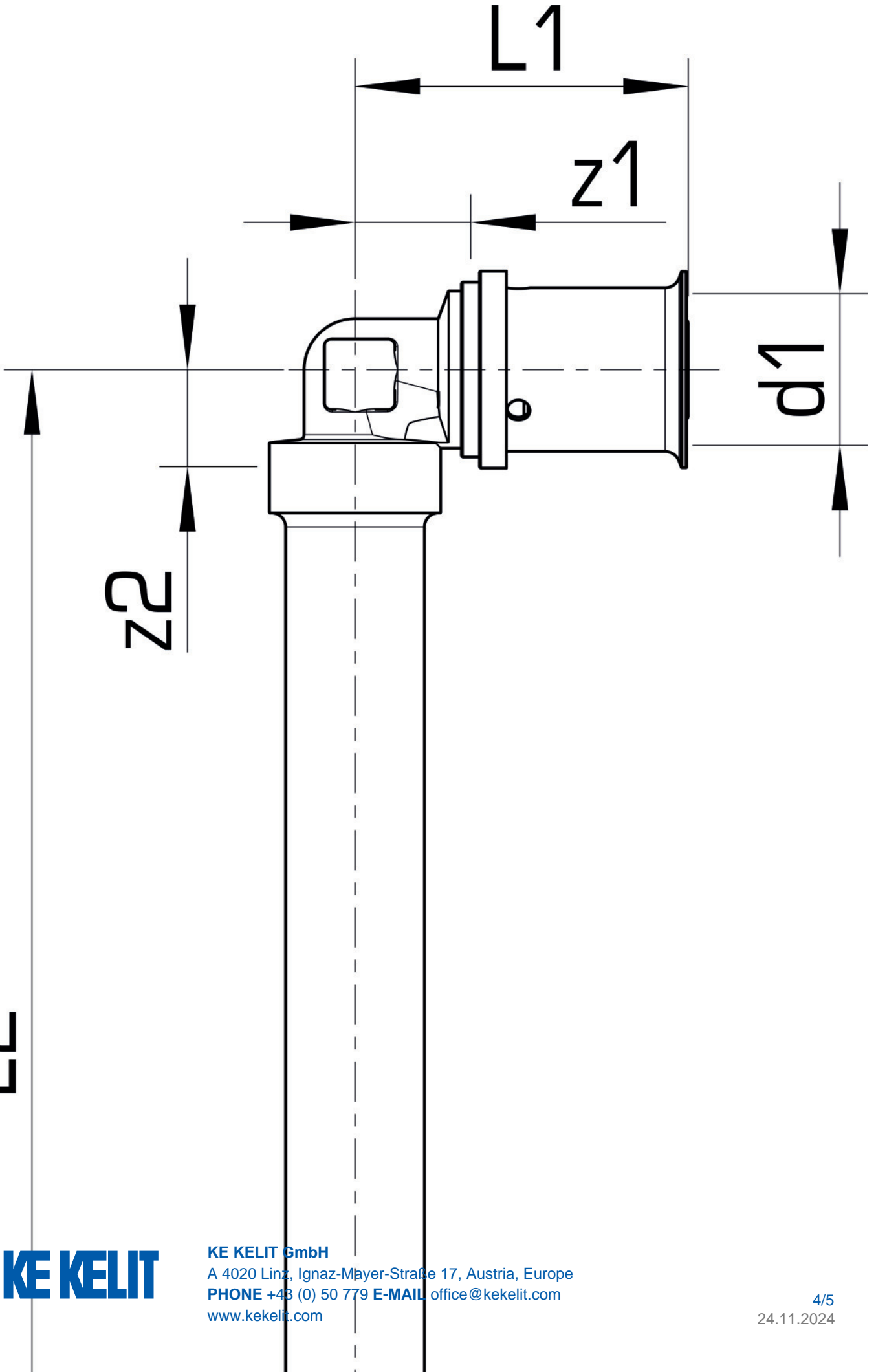

Art. No	label	d1 mm	d2 mm	L1 mm	L2 mm	z1 mm	z2 mm
71150B39	16/15/150	16	15	36	150	13,5	10,5



KE KELIT GmbH

A 4020 Linz, Ignaz-Mayer-Straße 17, Austria, Europe

PHONE +43 (0) 50 779 **E-MAIL** office@kekelit.com

www.kekelit.com