

KELOX

KMU450 KELOX-ULTRAX adaptor male 16x1/2"

71202B02

Areas of application

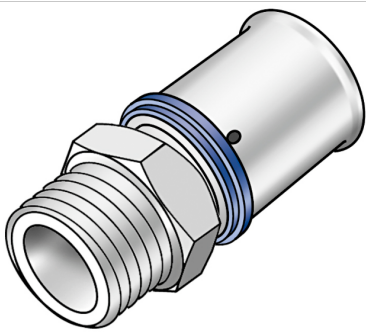

Press adaptor with male thread for sealing, made of non-porous metallized brass, incl. support sleeves with O-rings and steel or stainless steel press-fit sleeves, "leak before pressed"

Approvals:



Specifications

Article information

port 1	Pressing socket
port 2	Male thread, conical (NPT)
execution	1-part
design	Straight
press contour	U

Technical properties

maximum working pressure at 20 ° C	10
------------------------------------	----

Product information

VPE1	10 SA1
VPE2	200 KT1
weight	0,062 KGM
text	KELOX-ULTRAX adaptor male
INTRNR	74122000
main material group	KELOX
material group	KELOX-ULTRAX metal fittings
code	KMU450

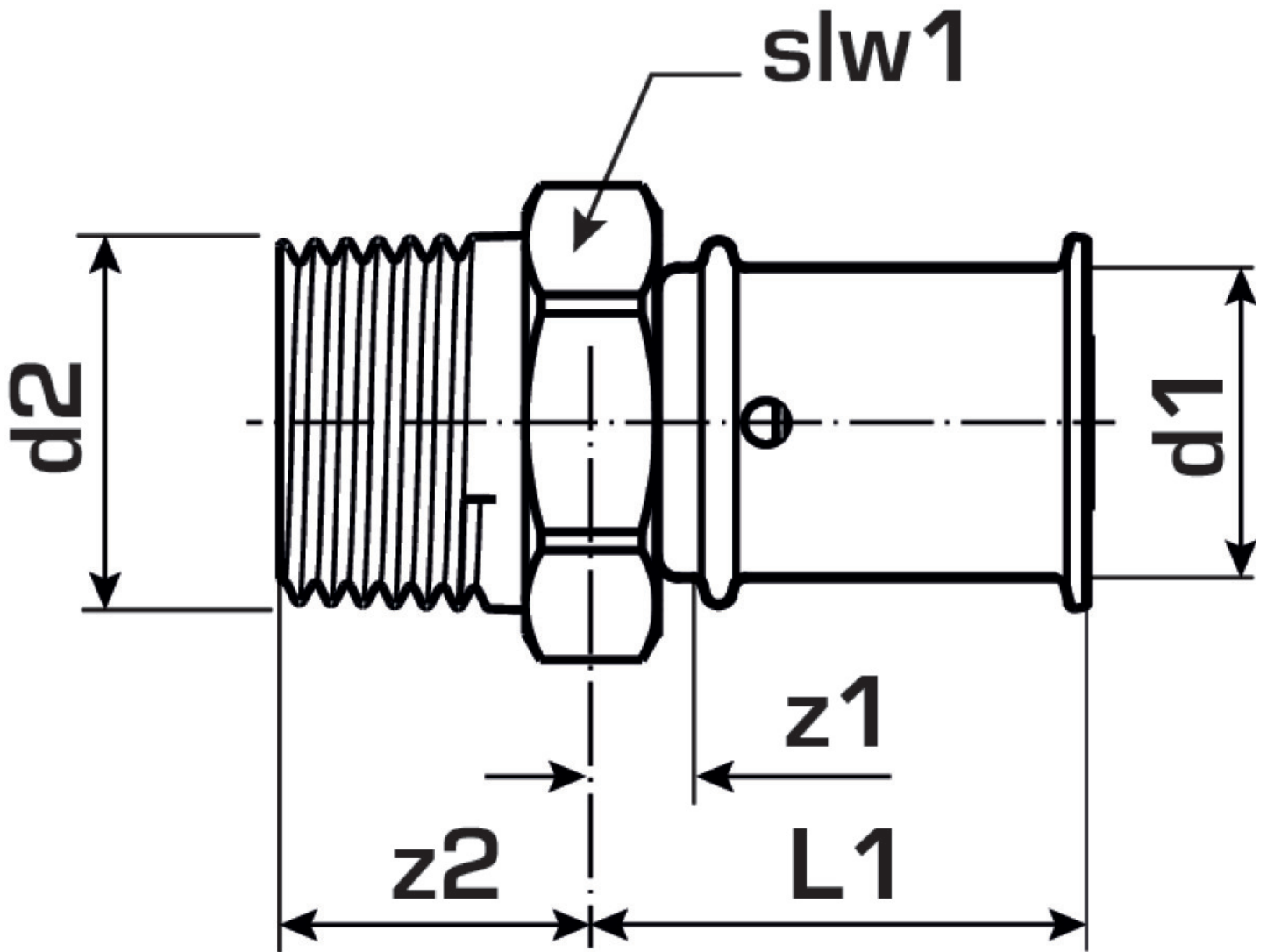

Art. No	label	d2	d1 mm	L1	z1 mm	z2	slw1
71202B02	16x1/2"	1/2" (15)	16	28	5	18	24