

KELOX^{SL}

KM809 KELOX SB left end piece 22 mm White

6405900

Areas of application

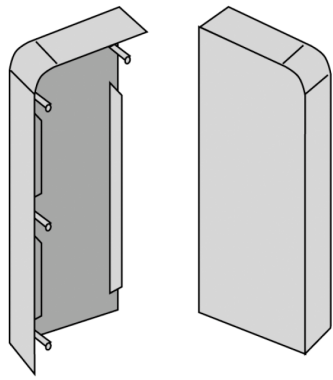

For covering open skirting board ends, made from polystyrene coated with embossed foil, 22mm

Specifications

Product information	
VPE1	10,00 SA1
weight	0,011 KGM
text	KELOX SB left end piece 22 mm
INTRNR	39203000
main material group	KELOX SL
material group	KELOX SL skirting boards and accessoriess
code	KM809

Art. No	label
6405900	White