

# CLIMATE FIX

KC590S CLIMATEFIX manifold 6/4" 6 L:620mm

7965060

## Areas of application

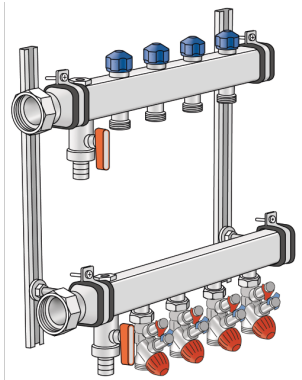

6/4" stainless steel flow and return flow bar with bleeding and emptying at the manifold end, connections with screwed-in 6/4" flat-sealing cap nut.

At the flow compact valve, control valve, regulator valve, shut-off valve and measuring valve 3/4" Euro-cone male, precise regulation with adjusting tools of 0.5 - 9.0 l/min pre-settable, which combines the zone valve and line regulator valve functions, flow and differential pressure measuring can be logged using a monitoring computer

On the return line thermostatic valve for setting the water amount, heating circuit outlets 3/4" euro cone with male thread, return flow valve bonnets to fit KM596 KELOX thermal motor including soundproofed steel consoles

Area of application: tmax. 80°C/6 bar

ATTENTION - WITHOUT KM220 Euro screw fitting!



**KE KELIT GmbH**

A 4020 Linz, Ignaz-Mayer-Straße 17, Austria, Europe

**PHONE** +43 (0) 50 779 **E-MAIL** [office@kekelit.com](mailto:office@kekelit.com)

[www.kekelit.com](http://www.kekelit.com)

# Specifications

## Article information

extendible 0

## Product information

VPE1	1 KT1
VPE2	24 PAL
weight	8,86 KGM
text	CLIMATEFIX manifold 6/4"
INTRNR	84818039
main material group	CLIMATEFIX
material group	CLIMATEFIX fittings
code	KC590S

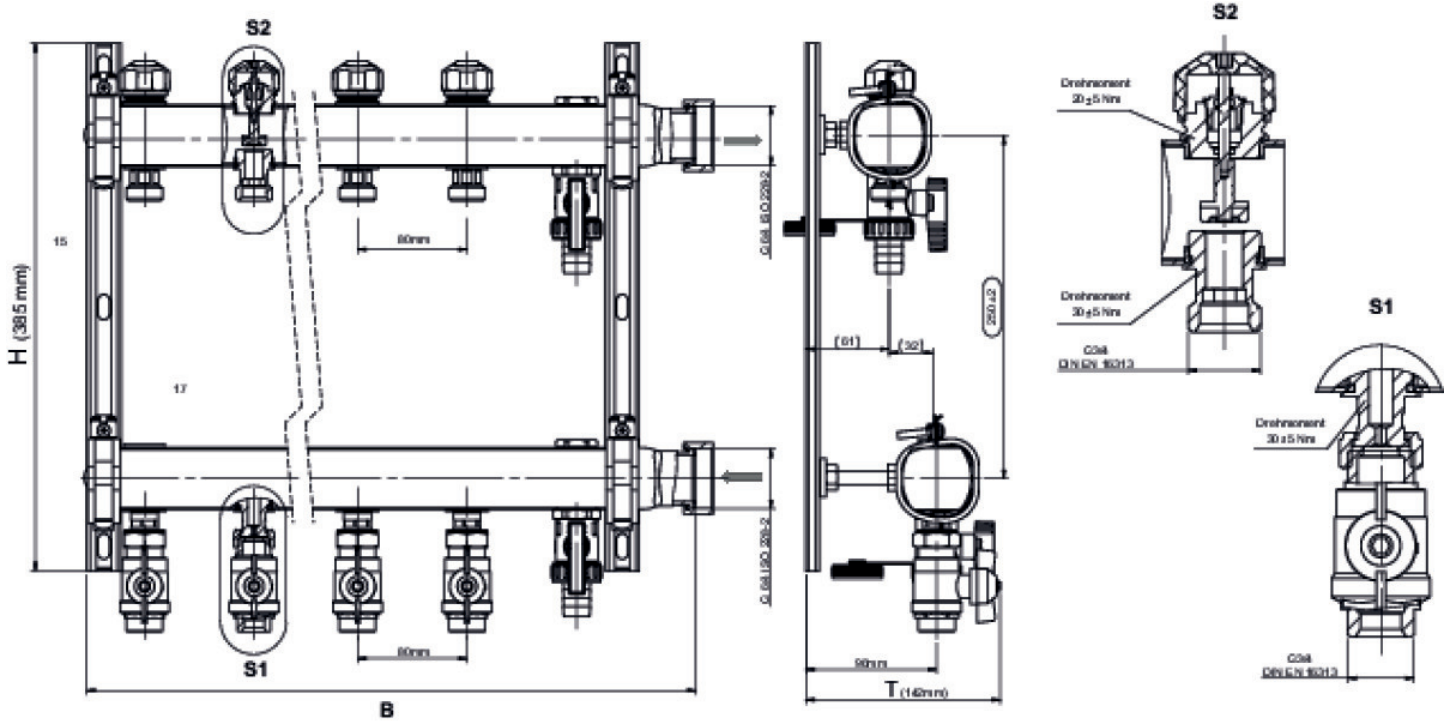

Art. No	label	t mm	t mm	h mm
7965060	6 L:620mm	142	610	385