

# KELOX

## KUC100 KELOX-ECO pipe 32x3

7033220

### Areas of application

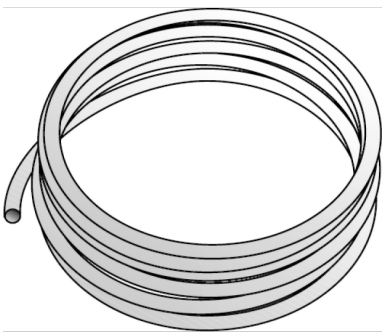

KELOX-ECO solid-wall pipe conforming to ÖNORM EN ISO 22391 made of PE-RT Type 2.

Connections can be made with KM screw fittings, KMP, KWP, KMU and KWX fittings.

Classification of operating conditions according to ÖNORM EN ISO 21003

Cold water application range: 20 °C - 10 bar

Warm water application range: 60 °C - 6 bar

Colour: white

Supplied in coils

## Approvals:



**KE KELIT GmbH**

A 4020 Linz, Ignaz-Mayer-Straße 17, Austria, Europe

**PHONE** +43 (0) 50 779 **E-MAIL** [office@kekelit.com](mailto:office@kekelit.com)

[www.kekelit.com](http://www.kekelit.com)

# Specifications

## Article information

<b>color</b>	white
<b>flexible</b>	Yes
<b>trade length</b>	50 m
<b>isolation</b>	No

## Technical properties

<b>maximum working pressure at 20 ° C</b>	10
<b>pipe weight</b>	0.260 kg/m
<b>pipe contents</b>	0.531 l/m
<b>lambda pipe</b>	0.40 W/(m.K)
<b>wall rawness</b>	0,007 mm
<b>expansion coefficient</b>	0,19 mm/(m.K)

## Product information

VPE1	50 ROL
VPE2	500 PAL
L	50 m
weight	0,26 KGM
text	KELOX-ECO pipe
INTRNR	39173900
main material group	KELOX
material group	KELOX pipes
code	KUC100

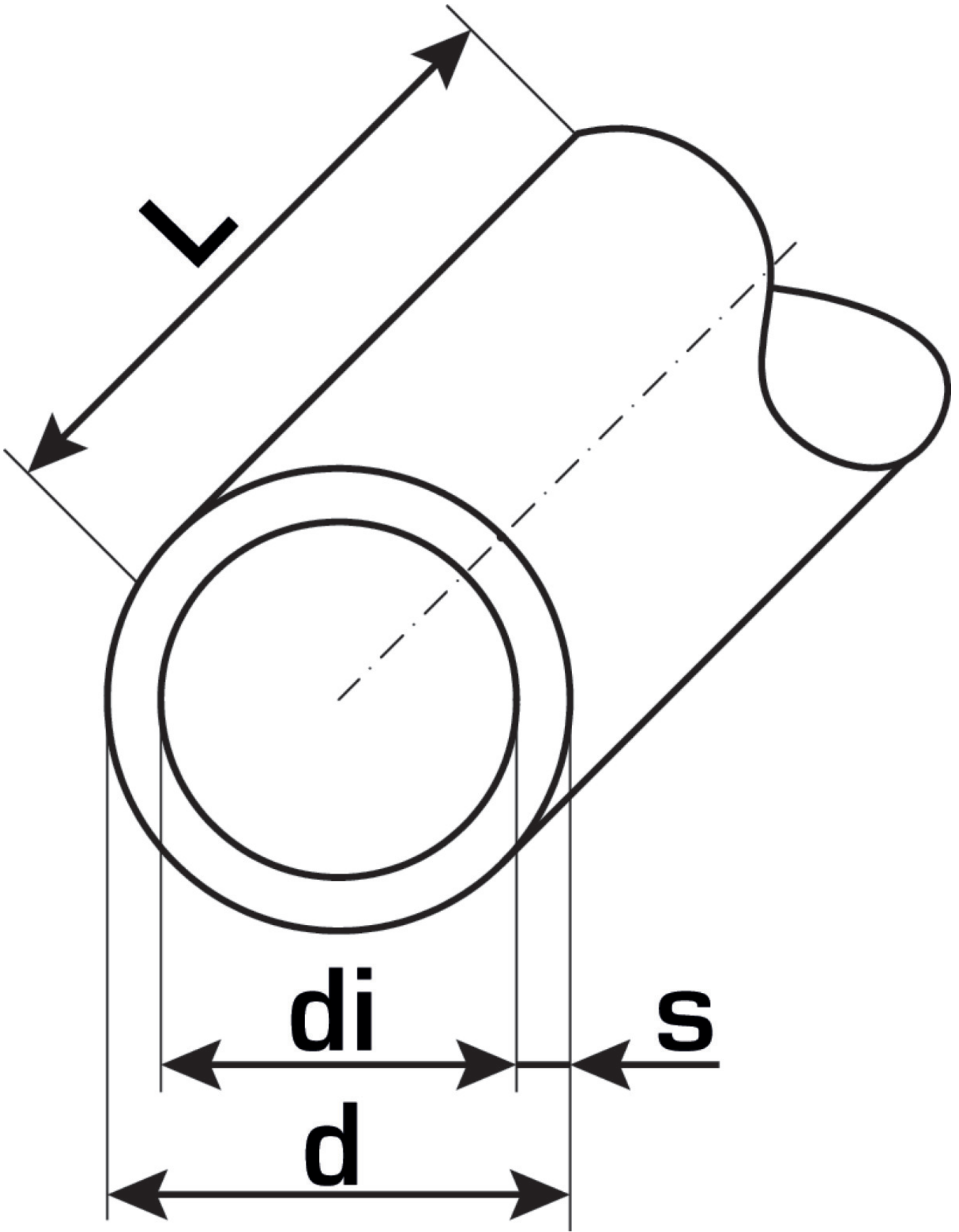

Art. No	label	d1 mm	pipe contents l/m	s mm
7033220	32x3	32	0.531	3



**KE KELIT GmbH**

A 4020 Linz, Ignaz-Mayer-Straße 17, Austria, Europe

**PHONE** +43 (0) 50 779 **E-MAIL** [office@kekelit.com](mailto:office@kekelit.com)

[www.kekelit.com](http://www.kekelit.com)