

KELOX

KUC133 KELOX-ECO Plus pipe - 13mm 25x2,5

7052520

Areas of application

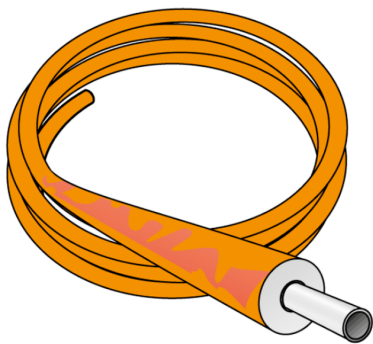

KELOX-ECO solid-wall pipe conforming to ÖNORM EN ISO 22391 made of PE-RT Type 2 with 9mm closed-cell soft foam insulation applied at the factory and plastic insulation protective sleeve made of viscoplastic PE foil. Connections can be made with KM screw fittings, KMP, KWP, KMU and KWX fittings.

Classification of operating conditions according to ÖNORM EN ISO 21003

Cold water application range: 20 °C - 10 bar

Warm water application range: 60 °C - 6 bar

Colour: orange

Supplied in coils

Approvals:



Specifications

Article information

color	weiß
colour isolation	blau
flexible	1
trade length	25 m
isolation	1

Technical properties

maximum working pressure at 20 ° C	10 bar
thick thermal insulation	13 mm
pipe weight	0,34 kg/m
pipe contents	0,314 l/m
lambda pipe	0,40 W/(m.K)
wall rawness	0,007 mm
expansion coefficient	0,19 mm/(m.K)

Product information

VPE1	25 ROL
VPE2	325 PAL
L	50 m
weight	0,34 KGM
text	KELOX-ECO Plus pipe - 13mm
INTRNR	39173900
main material group	KELOX
material group	KELOX isolierte pipes
code	KUC133

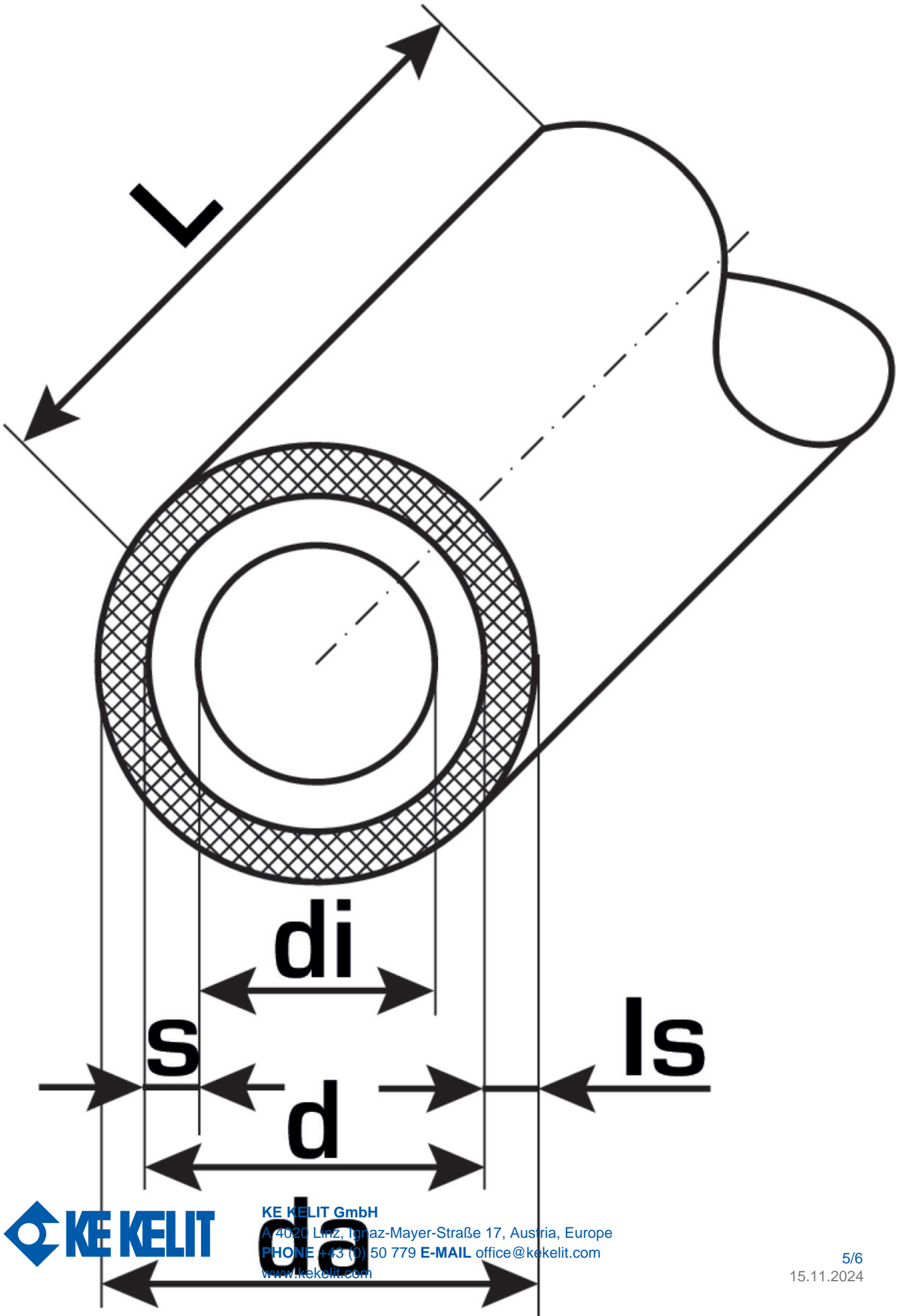

Art. No	label	d1 mm	d Jacket tube mm	pipe contents l/m	s mm
7052520	25x2,5	25	51	0,314	2,5



KE KELIT GmbH

A 4020 Linz, Ignaz-Mayer-Straße 17, Austria, Europe

PHONE +43 (0) 50 779 **E-MAIL** office@kekelit.com

www.kekelit.com