

KELOX_{FB}

KM572 KELOX flush-mounted visible part 1-4 L:
530mm

9000580

Areas of application

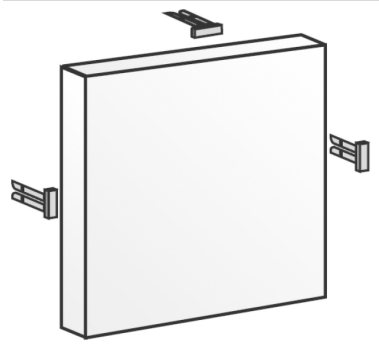

?Sendzimir-galvanised door with depth-adjustable surface-mounted visible part with magnetic holder; powder-coated

Colour: white (RAL 9016)

Depth: 130mm

Height: 670mm above finished floor

Specifications

Article information

colour 9016

Product information

VPE1 1,00 KT1

weight 8,500 KGM

text KELOX flush-mounted visible part

INTRNR 84818099

code KM572

Art. No	label	t mm
---------	-------	------

9000580	1-4 L: 530mm	130
---------	--------------	-----