

KELOX_{FB}

ULTRA PE-RT industrial surface manifold pipe
6/4" 8 L:780mm

7964080

Areas of application



6/4" stainless steel flow and return flow bar with bleeding and emptying at the manifold end, connections with screwed-in 6/4" flat-sealing cap nut. On the feed line ball valve, 3/4" non-porous metallized brass with euro cone male thread; on the return line thermostatic valve for setting the water amount, heating circuit outlets 3/4" euro cone with male thread, return flow valve bonnets to fit KM596 KELOX thermal motor including soundproofed steel consoles

Area of application: tmax. 80°C/6 bar

ATTENTION - WITHOUT KM220 Euro screw fitting!

Specifications

Product information

text

ULTRA PE-RT industrial surface manifold pipe 6/4"

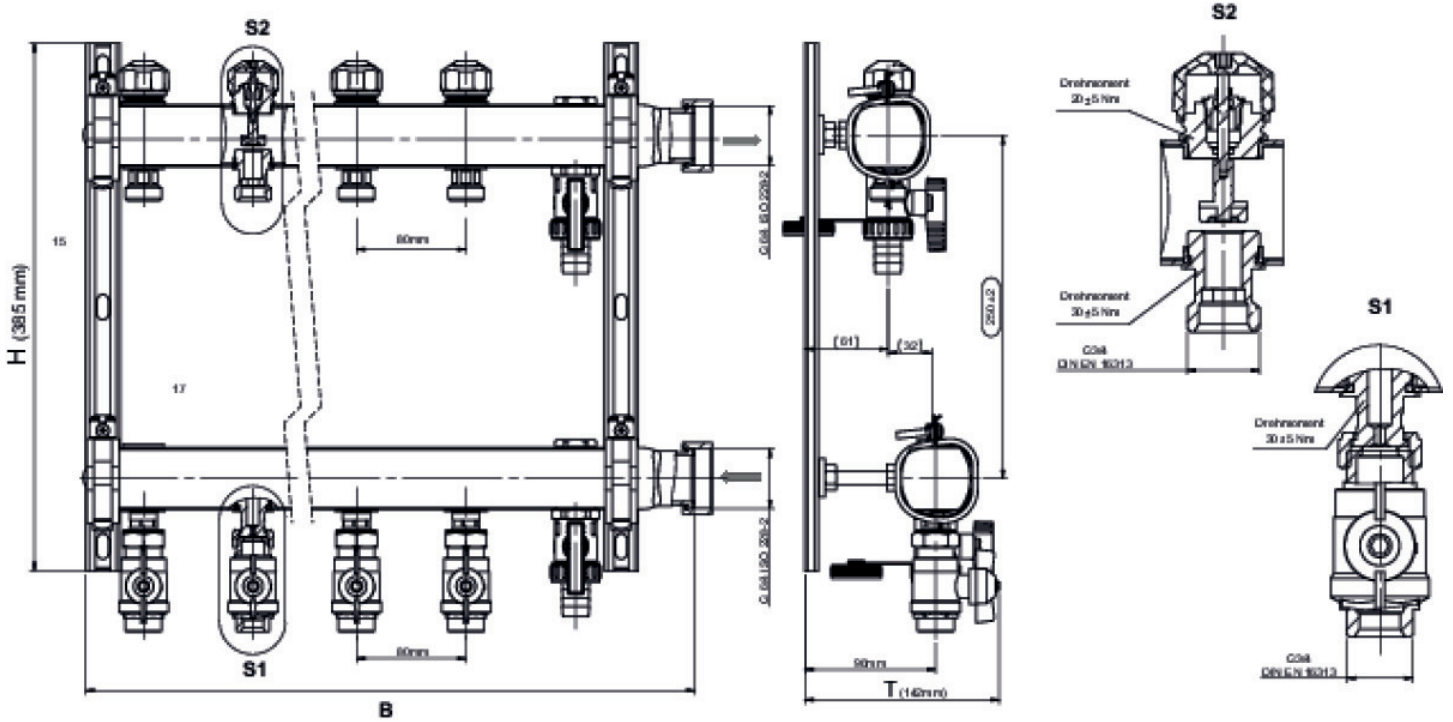

Art. No

label

7964080

8 L:780mm



KE KELIT GmbH

A 4020 Linz, Ignaz-Mayer-Straße 17, Austria, Europe

PHONE +43 (0) 50 779 E-MAIL office@kekelit.com

www.kekelit.com

2/2

15.11.2024