

KELOX

KMP447X KELOX-PROTEC CLIX T-Stück mit Abgang IG 25x3/4"

730240E04

Areas of application

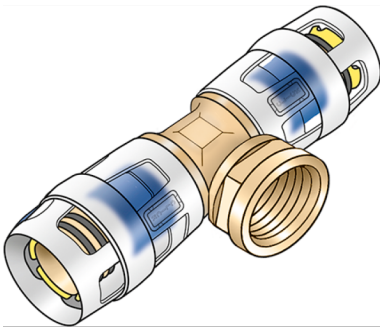

Steck-T-Stück mit IG, aus entzinkungsbeständigem Messing (DZR), inkl. Stechhülse aus transparentem Polyamid mit Einschubklickgeräusch, sowie haptischem und optischem Einsteckindikator, O-Ringen, Auszugsbarrieren und Protectorring als Einschubsicherung KEINE Gewinderohre und Tempergussfittings eindrehen!

Approvals:



KE KELIT GmbH

A 4020 Linz, Ignaz-Mayer-Straße 17, Austria, Europe

PHONE +43 (0) 50 779 E-MAIL office@kekelit.com

www.kekelit.com

Specifications

Article information

| | |
|-----------|-------------------------|
| port 1 | Einsteck (Push-Fitting) |
| port 2 | Innengewinde (metrisch) |
| port 3 | Einsteck (Push-Fitting) |
| execution | T-Stück |
| angle | 90 ° |

Technical properties

| | |
|------------------------------------|--------|
| maximum working pressure at 20 ° C | 10 bar |
|------------------------------------|--------|

Product information

| | |
|---------------------|---|
| VPE1 | 4,00 SA1 |
| VPE2 | 44,00 KT1 |
| weight | 0,231 KGM |
| text | KELOX-PROTEC CLIX T-Stück mit Abgang IG |
| INTRNR | 74122000 |
| main material group | KELOX |
| material group | KELOX-PROtec Steckformstücke |
| code | KMP447X |

