

KELOX

KMP450X KELOX-PROTEC CLIX adapter with male thread 32x1/2"

730202F02

Areas of application

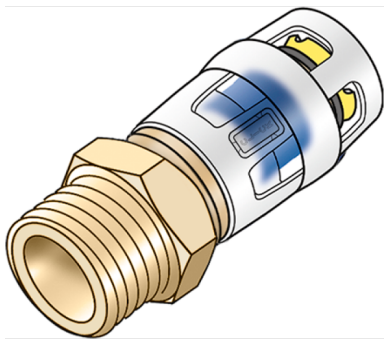

Push-in adapter with male thread, made of dezincification-resistant (DZR) brass, incl. push-on sleeve made of transparent polyamide with insertion click noise, as well as haptic and optical insertion indicator, O-rings, withdrawal barriers and protector ring as an insertion locking device

Approvals:



Specifications

Article information

port 1	Plug-in
port 2	Female thread cylindrical BSPT-Rp (ISO 7-1)
execution	Miscellaneous
design	Straight

Technical properties

maximum working pressure at 20 ° C	10 bar
------------------------------------	--------

Product information

VPE1	10,00 SA1
VPE2	60,00 KT1
weight	0,118 KGM
text	KELOX-PROTEC CLIX adapter with male thread
INTRNR	74122000
main material group	KELOX
material group	KELOX-PROtec pushfittings
code	KMP450X

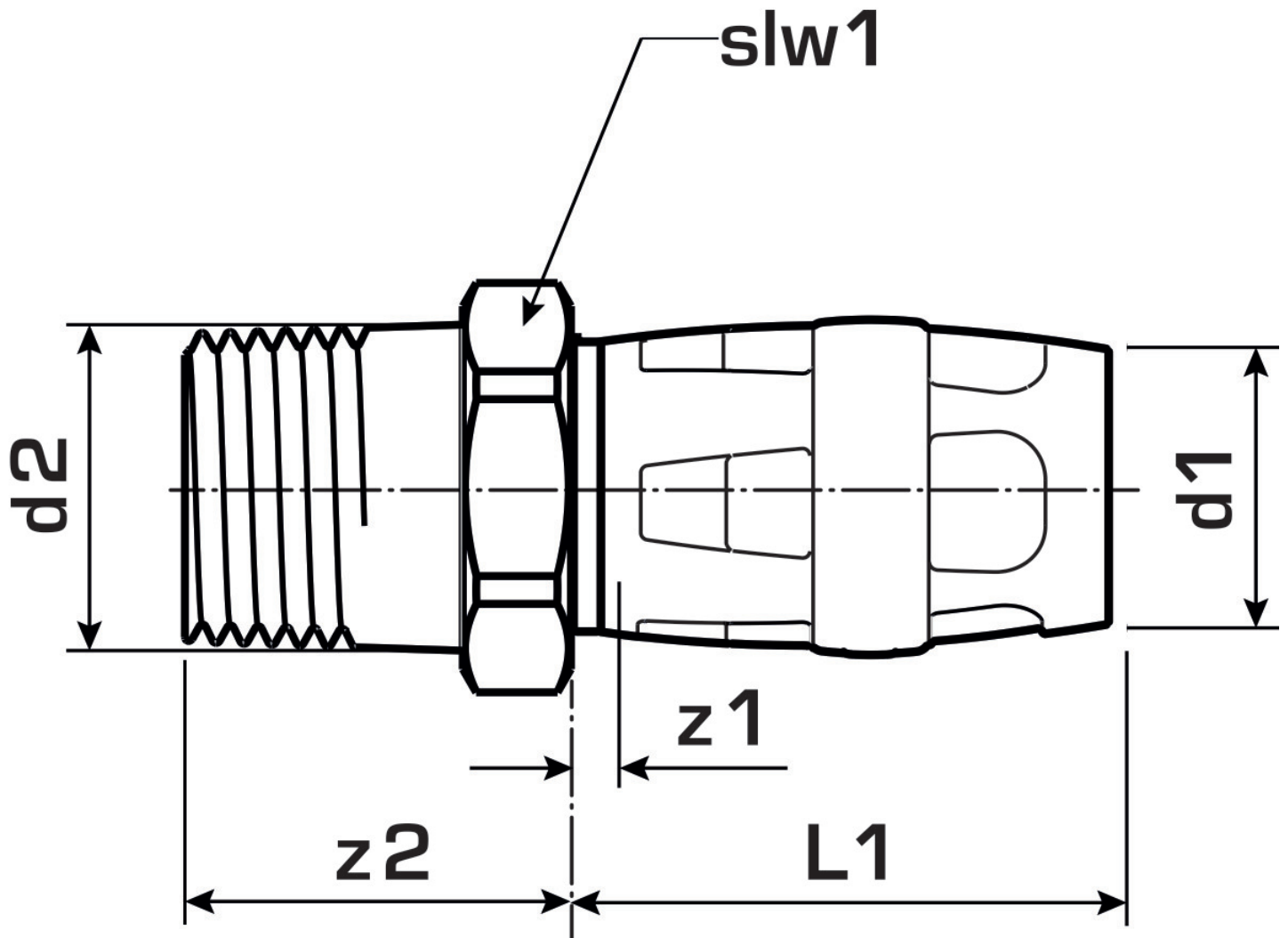

Art. No	label	d2	d1 mm	L1 mm	z1 mm	z2 mm	slw1 mm
730202F02	32x1/2"	1/2" (15)	32	31	4	39	30