

KELOX

KMP455X KELOX-PROTEC CLIX screw fitting with female thread 32x5/4"

730203F06

Areas of application

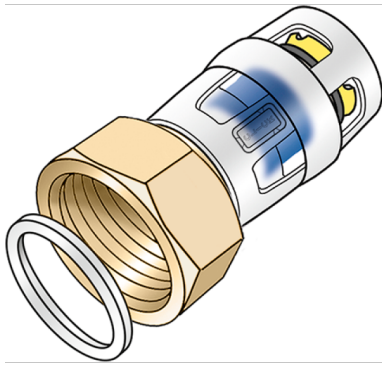

Plug-in screw fitting with female thread for connecting to fittings, e.g. filters, manifolds, pumps,..... made of dezincification-resistant brass (DZR), incl. push-on sleeve made of transparent polyamide with insertion click noise, as well as haptic and optical insertion indicator, O-rings, withdrawal barriers and protector ring as insertion locking device, flat-sealing incl. seal

Approvals:



Specifications

Article information

port 1	Plug-in
port 2	Female thread cylindrical BSPT-Rp (ISO 7-1)
design	Straight

Technical properties

maximum working pressure at 20 ° C	10 bar
------------------------------------	--------

Product information

VPE1	8,00 SA1
VPE2	56,00 KT1
weight	0,232 KGM
text	KELOX-PROTEC CLIX screw fitting with female thread
INTRNR	74122000
main material group	KELOX
material group	KELOX-PROtec pushfittings
code	KMP455X



Art. No	label	d2	d1 mm	L1 mm	L2 mm	z1 mm	z2 mm	slw2 mm
730203F06	32x5/4"	1 1/4"	32	43	32	4	20	47