

KELOX

KMP457X KELOX-PROTEC CLIX adapter with female thread 20x1/2"

730206D02

Areas of application

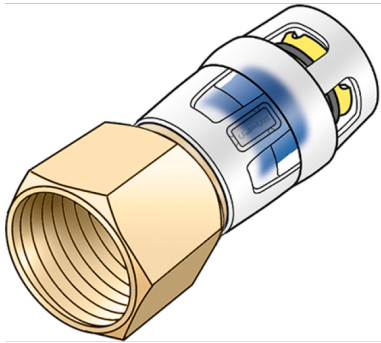

Plug-in adapter with female thread, made of dezincification-resistant brass (DZR), incl. push-on sleeve made of transparent polyamide with insertion click noise, as well as haptic and optical insertion indicator, O-rings, withdrawal barriers and a protector ring as an insertion locking device
DO NOT screw in any threaded pipes and cast iron fittings!

Approvals:



Specifications

Article information

port 1	Plug-in
port 2	Female thread cylindrical BSPT-Rp (ISO 7-1)
design	Straight

Technical properties

maximum working pressure at 20 ° C	10 bar
------------------------------------	--------

Product information

VPE1	10,00 SA1
VPE2	180,00 KT1
weight	0,061 KGM
text	KELOX-PROTEC CLIX adapter with female thread
INTRNR	74122000
main material group	KELOX
material group	KELOX-PROtec pushfittings
code	KMP457X

slw2

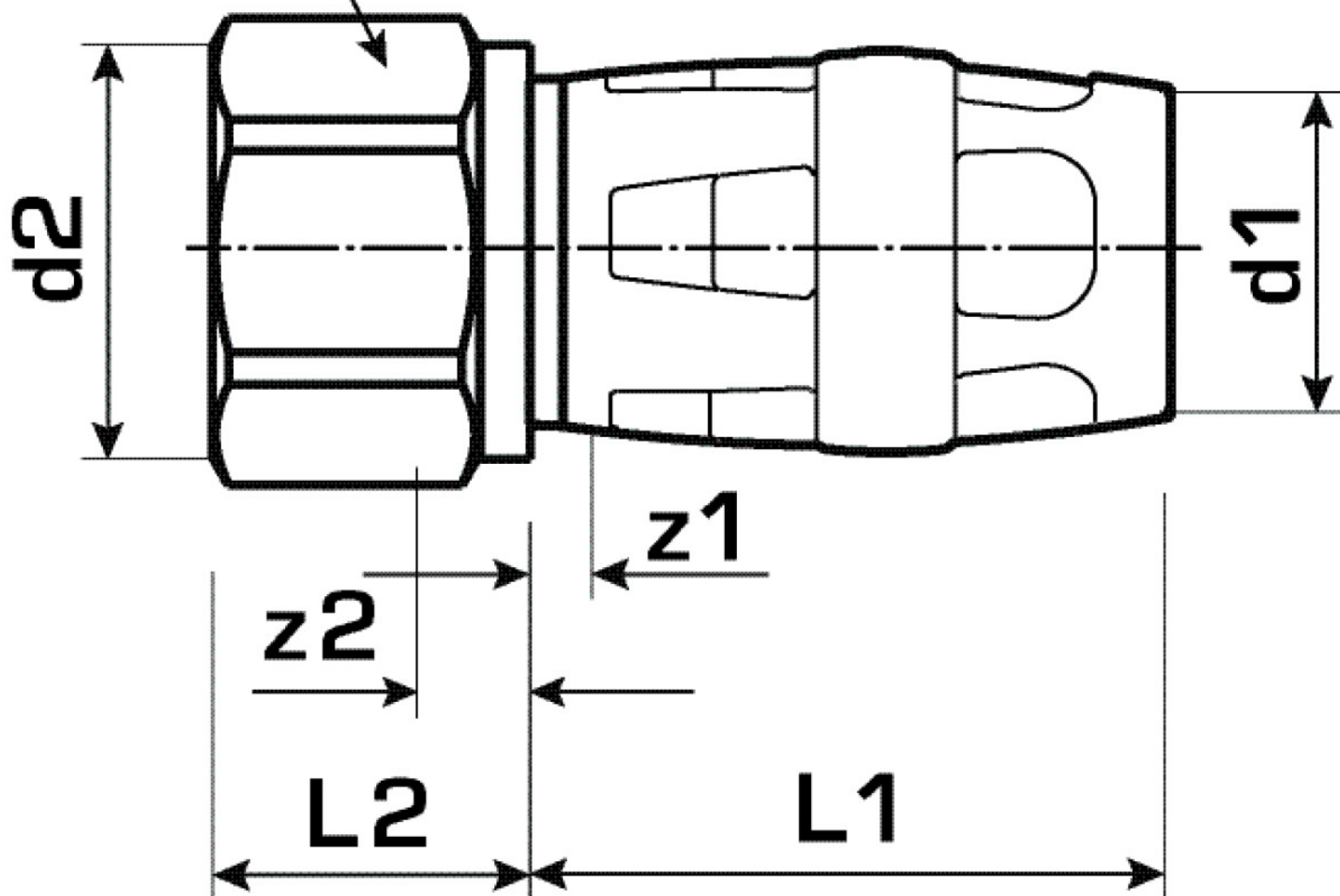

Art. No	label	d2 Zoll	d1 mm	L1 mm	L2 mm	z1 mm	z2 mm	slw2 mm
730206D02	20x1/2"	1/2 Zoll (15)	20	37	18	4	3	24