

# KELIT P

## P7100 KELIT house infeed

3560800

### Areas of application

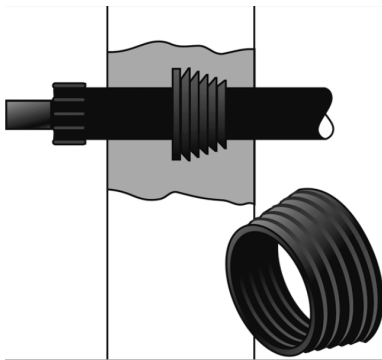

House lead-in or wall ducts (sealing ring) made of neoprene, for watertight pipe ducts with normal soil water. In the case of higher (pressing) groundwater, we recommend using PEX77 annular seals.

# Specifications

## Product information

<b>casing DA</b>	200-202
<b>VPE1</b>	1,00 STK
<b>weight</b>	0,520 KGM
<b>text</b>	KELIT house infeed
<b>INTRNR</b>	39174000
<b>main material group</b>	KELIT P
<b>material group</b>	KELIT P sleeves and accessories
<b>code</b>	P7100

## Art. No

3560800



**KE KELIT GmbH**

A 4020 Linz, Ignaz-Mayer-Straße 17, Austria, Europe

**PHONE** +43 (0) 50 779 **E-MAIL** office@kekelit.com

[www.kekelit.com](http://www.kekelit.com)