

KE1008 KELEN-PP-RCT CX pipe - PN16 90x12.3

30090005

Areas of application

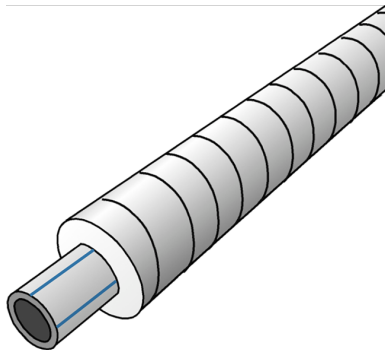

Pre-insulated drinking water pipe system based on ÖNORM EN ISO 15874

Medium pipe: KELEN made of polypropylene copolymer (PP-R), adhesion-pretreated

Application area: 20°C/16 bar - 60°C/8 bar

Insulation: PUR rigid foam

Jacket pipe: 0.6 mm galvanised folded spiral sheet metal

Length: 6m

Approvals:



KE KELIT GmbH

A 4020 Linz, Ignaz-Mayer-Straße 17, Austria, Europe

PHONE +43 (0) 50 779 E-MAIL office@kekelit.com

www.kekelit.com

Specifications

Product information	
casing DA	180
VPE1	6,00 STG
L	6 m
weight	7,590 KGM
text	KELEN-PP-RCT CX pipe - PN16
INTRNR	39172290
main material group	KELEN CX/PE
material group	KELEN CX/PE pipes and fittings
code	KE1008

Art. No	label
30090005	90x12.3