

# KELEN

## KE06 KELEN ALU-composite pipe - PN20 32x4.4

1653201

### Areas of application

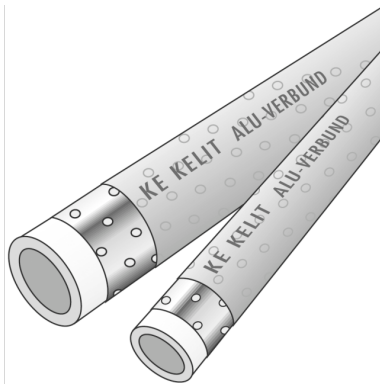

KELEN ALU - composite pipe conforming to ÖNORM EN ISO 15874, made of polypropylene copolymer (PP-R), mechanically stabilising aluminium pipe attached to the outer wall of the medium pipe with a bonding agent and protective layer

Application area: 20°C/20 bar - 70°C/8 bar

Colour: medium pipe is of natural colour, protection layer is grey

Length: 4m

## Approvals:



# Specifications

## Article information

color blau

trade length 4 m

## Technical properties

maximum working pressure at 20 ° C 20 bar

pipe weight 0,47 kg/m

pipe contents 0,42 l/m

lambda pipe 0,24 W/(m.K)

wall rawness 0,007 mm

expansion coefficient 0,035 mm/(m.K)

## Product information

DIM2 23,2

VPE1 40,00 BND

L 4 m

weight 0,470 KGM

text KELEN ALU-composite pipe - PN20

INTRNR 39172290

main material group KELEN

material group KELEN pipes

code KE06

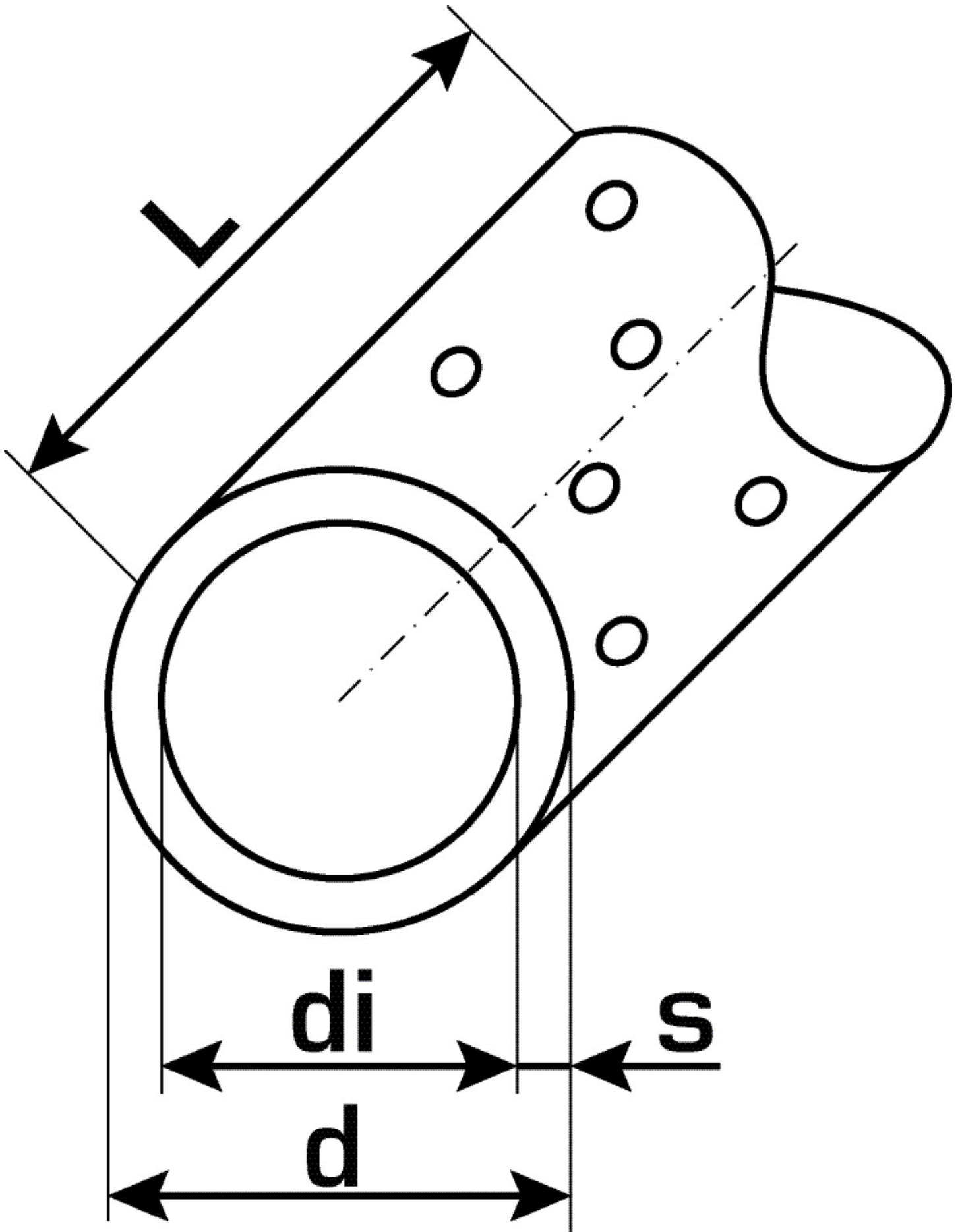

Art. No	label	d1 mm	pipe contents l/m	s mm
1653201	32x4.4	32	0,42	4,4



**KE KELIT GmbH**

A 4020 Linz, Ignaz-Mayer-Straße 17, Austria, Europe

**PHONE** +43 (0) 50 779 **E-MAIL** [office@kekelit.com](mailto:office@kekelit.com)

[www.kekelit.com](http://www.kekelit.com)