

KELEN

KE47 KELEN saddle fitting 63-125x25

2475501

Areas of application

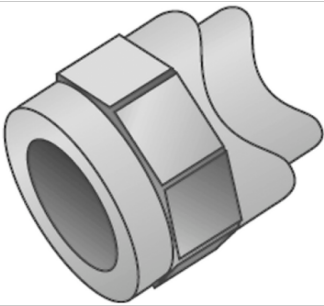

KELEN Polyfusion welding fitting for connecting pipes with fittings made of the same material (no reduction of internal diameter). For welding directly to pipelines that have already been installed; the welding is carried out with a WZ124 saddle welding tool

Approvals:



Specifications

Product information	
VPE1	5,00 SA1
VPE2	100,00 KT1
VPE3	600,00 KT2
VPE4	9600,00 PAL
weight	0,021 KGM
text	KELEN saddle fitting
INTRNR	39174000
main material group	KELEN
material group	KELEN plastic fittings
code	KE47



Art. No	label	d1 mm	L2 mm	z1 mm
2475501	63-125x25	25	15	13