

# KELEN

## KE00-LX13 KELEN PP-RCT LX-SENSO pipe - PN20 20x3.4

1520131

### Areas of application

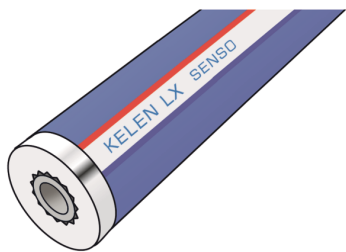

KELEN PP-RCT SENSO drinking water pipe system conforming to ÖNORM EN ISO 15874 made of polypropylene (PP-RCT) with factory-installed 13 mm soft-foam insulation, can be located electronically; outer layer consisting of woven tape fabric and viscoplastic polymer alloy

Application area: 20°C/20 bar - 70°C/10 bar

Length: 4m

## Approvals:



# Specifications

## Technical properties

isolation thickness	13 mm
pipe weight	0,29 kg/m
pipe contents	0,14 l/m
thermal conductivity	0,039 W/(m.K)
diameter inner tube	20 mm

## Product information

DIM2	13,2
VPE1	40,00 BND
VPE2	1400,00 HOB
L	4 m
weight	0,264 KGM
text	KELEN PP-RCT LX-SENSO pipe - PN20
INTRNR	39172290
main material group	KELEN
material group	KELEN-LX pipes
code	KE00-LX13

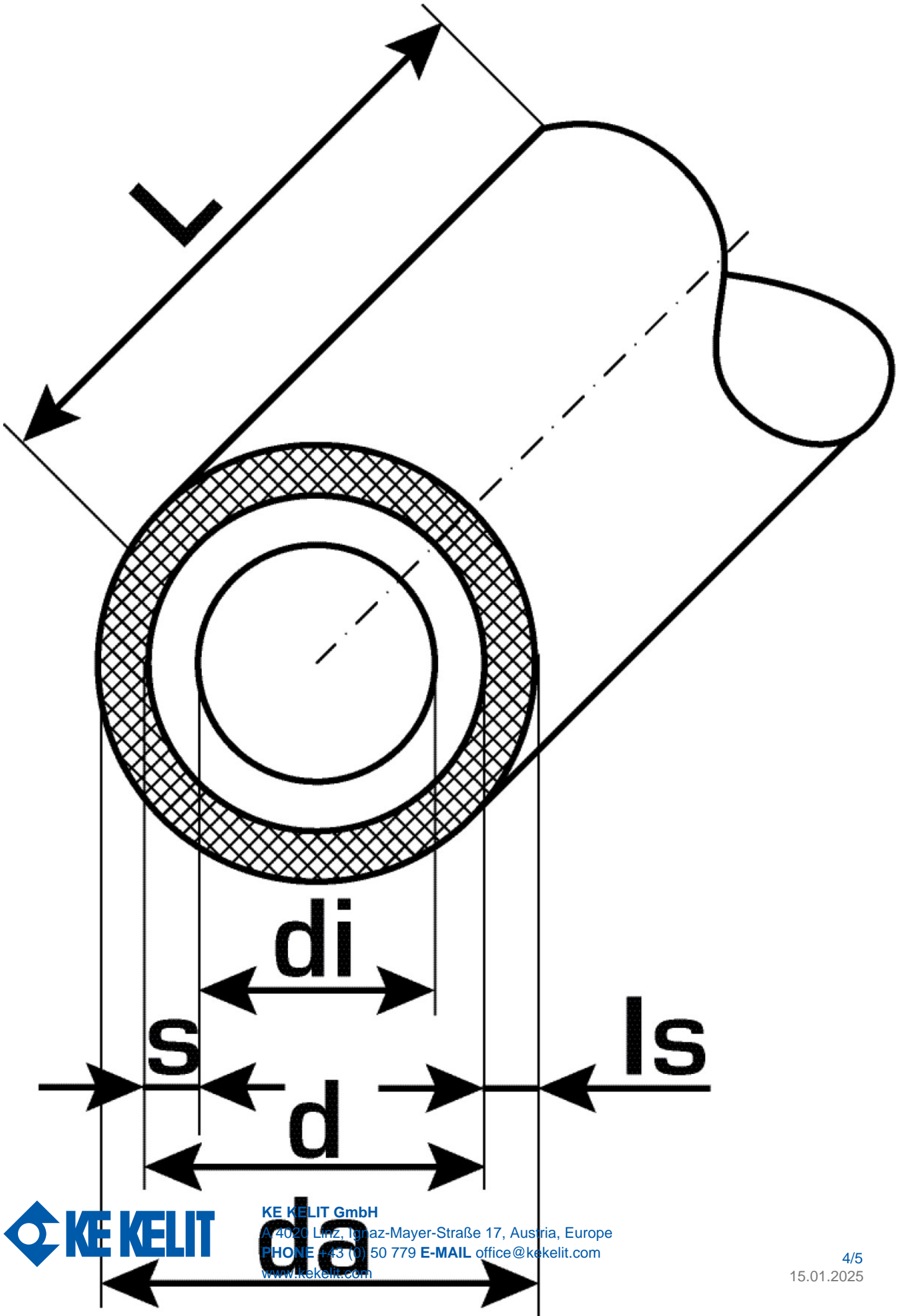

Art. No	label	d mm	pipe contents l/m
1520131	20x3.4	13,2	0,14



**KE KELIT GmbH**

A 4020 Linz, Ignaz-Mayer-Straße 17, Austria, Europe

**PHONE** +43 (0) 50 779 **E-MAIL** [office@kekelit.com](mailto:office@kekelit.com)

[www.kekelit.com](http://www.kekelit.com)