

KELEN

KE11 KELEN PP-RCT adapter male 32x3/4"

2598001

Areas of application



KELEN PP-RCT Polyfusion welding fitting for connecting pipes with fittings made of the same material (no reduction of internal diameter), with injected male thread made of dezincification-resistant brass, non-porous metal plating, thread conforms to ÖNORM EN 10226

System parts marked with an "S" are produced with a wrench attachment connection

Approvals:



Specifications

Article information

port 1	Kunststoffschweißmuffe
port 2	Außengewinde konisch (NPT)
execution	2-part
design	gerade

Product information

VPE1	5,00 SA1
VPE2	40,00 KT1
VPE3	160,00 KT2
VPE4	3840,00 PAL
weight	0,154 KGM
text	KELEN PP-RCT adapter male
INTRNR	39174000
main material group	KELEN
material group	KELEN metal fittings
code	KE11

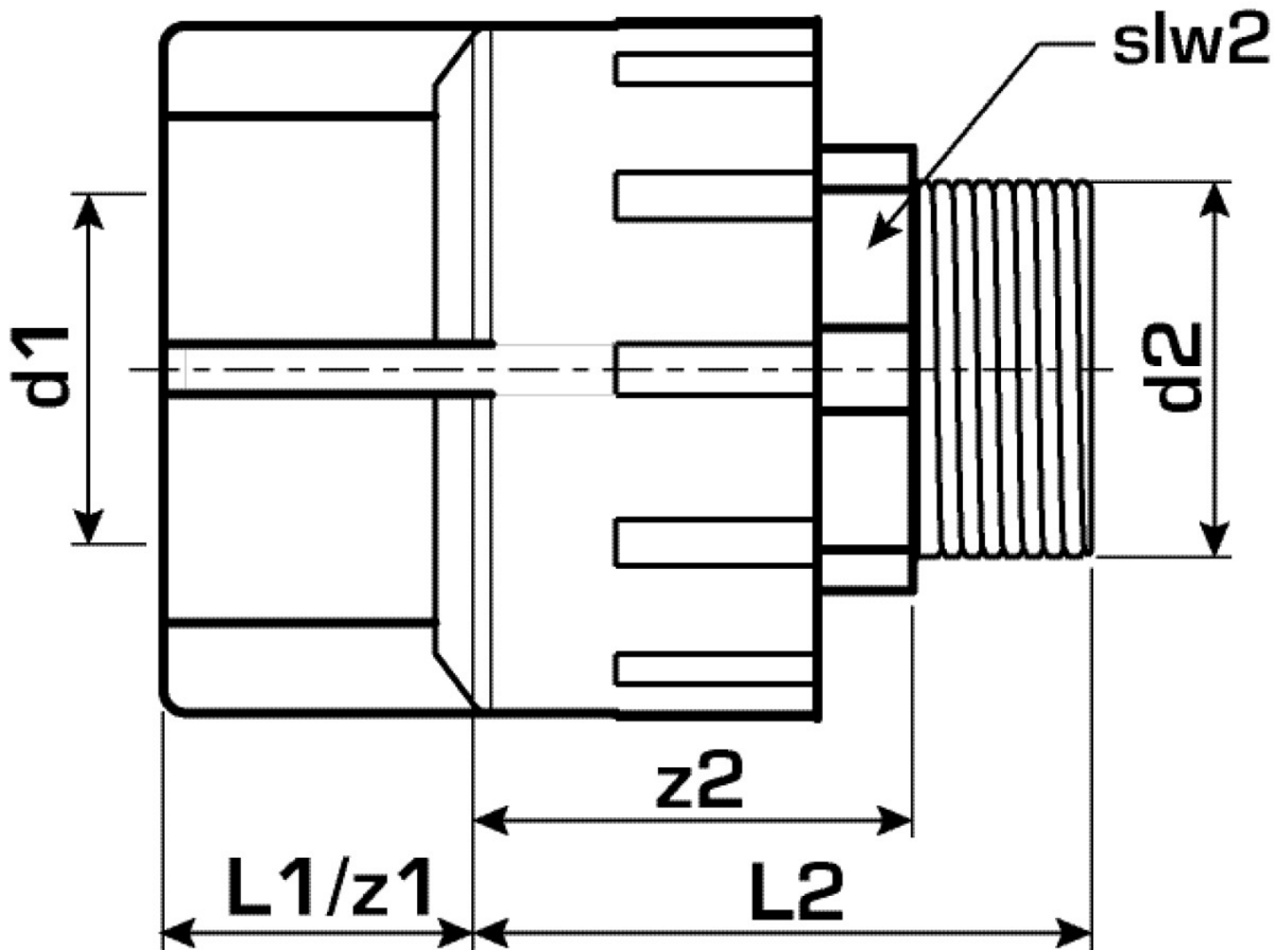

Art. No	label	d2	d1 mm	L1 mm	L2 mm	z1 mm	z2 mm
2598001	32x3/4"	3/4 Zoll (20)	32	23	37	23	22