

KELEN

KE23 KELEN PP-RCT elbow adapter 90° female 25x3/4"

2606001

Areas of application



KELEN PP-RCT Polyfusion welding fitting for connecting pipes with fittings made of the same material (no reduction of internal diameter), with injected male thread made of dezincification-resistant brass, non-porous metal plating, threads conform to ÖNORM EN 10226

System parts marked with an "S" are produced with a wrench attachment connection

Do NOT connect to threaded pipes or to cast iron fittings!

Approvals:



Specifications

Article information

port 1	Kunststoffschweißmuffe
port 2	Innengewinde zylindrisch BSPT-Rp (ISO 7-1 / EN 10226-1)
execution	2-part
design	Bogen
angle	90 °

Product information

VPE1	10,00 SA1
VPE2	60,00 KT1
VPE3	240,00 KT2
VPE4	5760,00 PAL
weight	0,114 KGM
text	KELEN PP-RCT elbow adapter 90° female
INTRNR	39174000
main material group	KELEN
material group	KELEN metal fittings
code	KE23

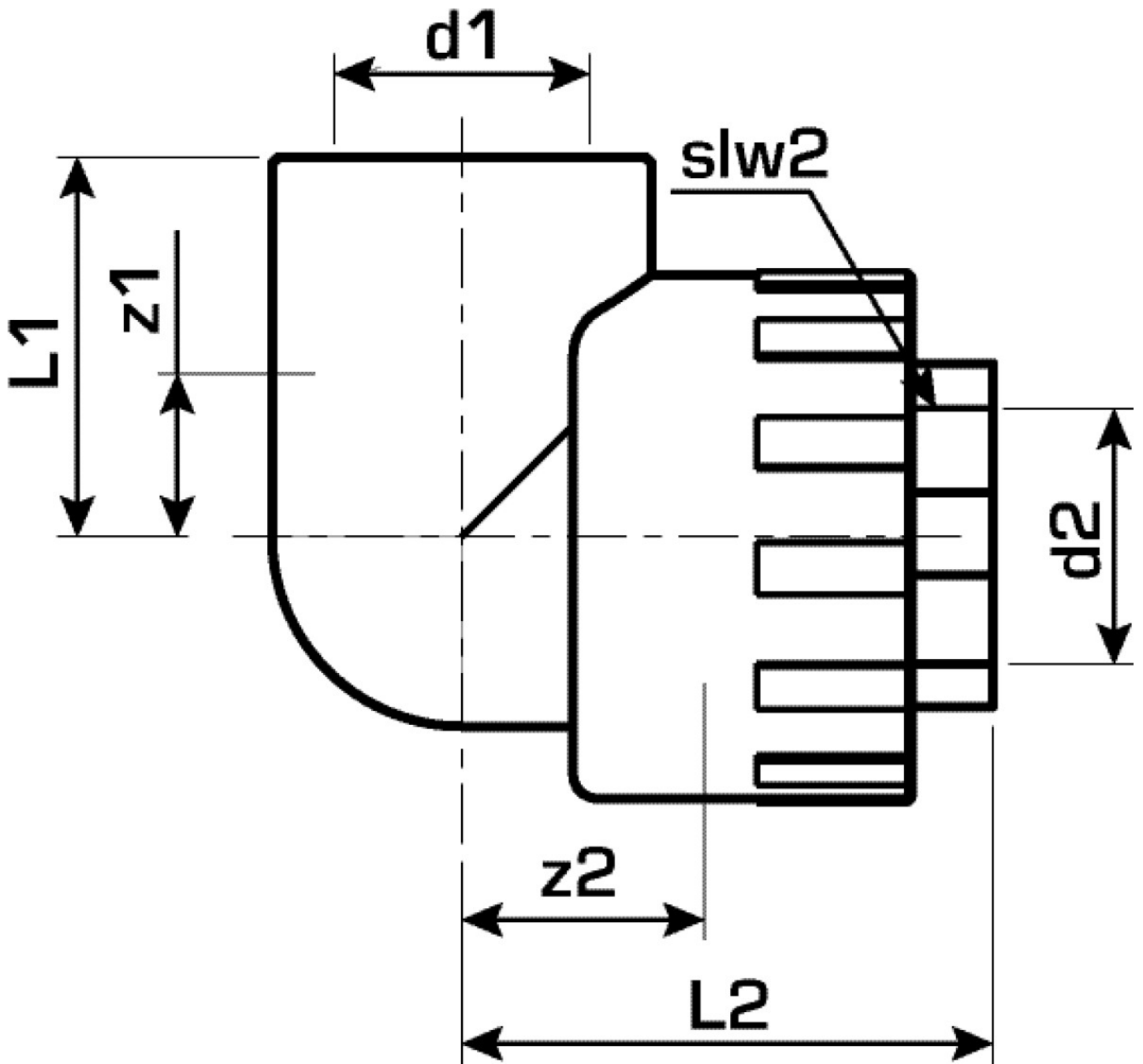

Art. No	label	d1 mm	L1 mm	L2 mm	z1 mm	z2 mm
2606001	25x3/4"	25	37	37	17	21