

KELEN

KE51 KELEN PPR ball valve PN16 32

2662301

Areas of application

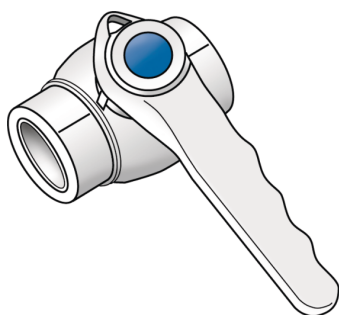

KELEN ball valve polyfusion (PP-R) moulded fitting for connecting pipes and fittings made of the same material without narrowing the cross section.

Approvals:



Specifications

Article information

port 1	Kunststoffschweißmuffe
port 2	Kunststoffschweißmuffe
execution	gerade

Product information

VPE1	5,00 SA1
VPE2	20,00 KT1
VPE3	80,00 KT2
weight	0,319 KGM
text	KELEN PPR ball valve PN16
INTRNR	39174000
main material group	KELEN
material group	KELEN metal fittings
code	KE51



KE KELIT GmbH

A 4020 Linz, Ignaz-Mayer-Straße 17, Austria, Europe

PHONE +43 (0) 50 779 **E-MAIL** office@kekelit.com

www.kekelit.com

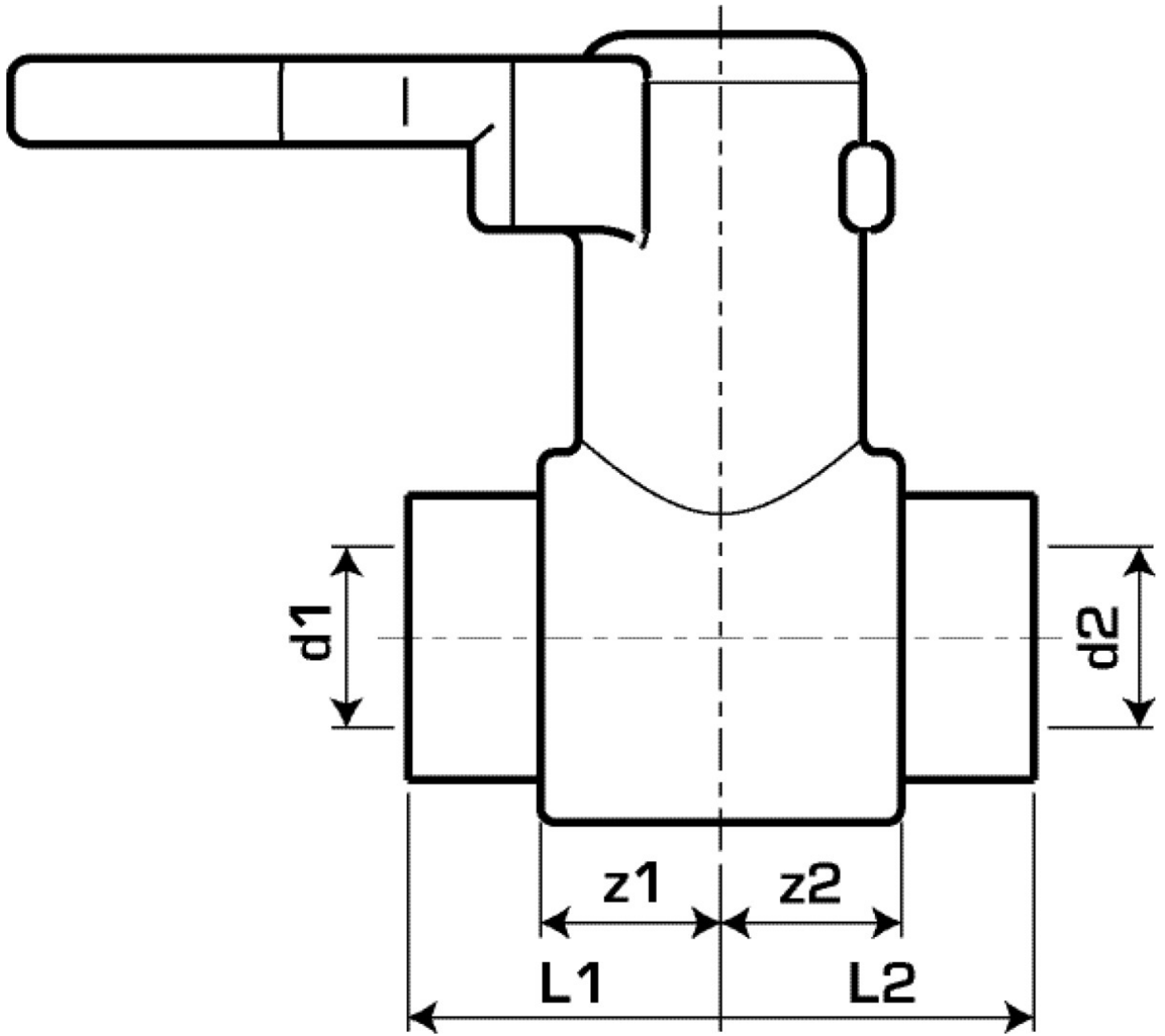

Art. No	label	d1 mm	d2 mm	L1 mm	L2 mm	z1 mm	z2 mm
2662301	32	32	32	42	42	22	22