

# KELEN

## K19A KELIT seal set for loose flange KE18 - steel flange 20 4-hole

2730710

### Areas of application

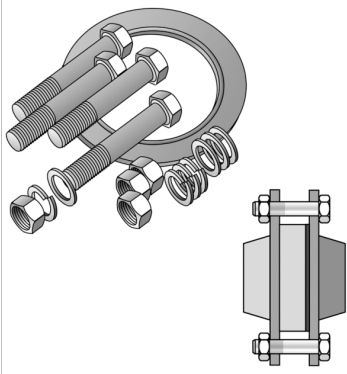

Incl. screws, nuts, spring washers, shims and EPDM seal with steel insert, screw length aligned with KE18 collar bushing with K19 loose flange mounted on steel flange  
EPDM seal with steel insert available separately!

### Approvals:



# Specifications

Product information	
VPE1	1,00 SA1
weight	0,428 KGM
text	KELIT seal set for loose flange KE18 - steel flange
INTRNR	84849000
main material group	KELEN
material group	KELEN accessories
code	K19A

Art. No	label
2730710	20 4-hole