

KELEN

K19K KELIT seal set for loose flange KE18 - KE18 20 4-hole

2731710

Areas of application

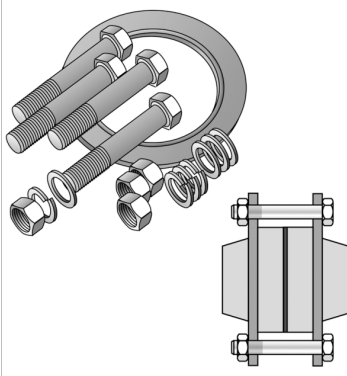

Incl. screws, nuts, washers, shims and EPDM seal with steel insert, screw length aligned with 2 units
KE18 collar bushing with 2 units K19 loose flange
EPDM seal with steel insert separately available!

Approvals:



Specifications

| Product information | |
|---------------------|---|
| VPE1 | 1,00 SA1 |
| weight | 0,428 KGM |
| text | KELIT seal set for loose flange KE18 - KE18 |
| INTRNR | 84849000 |
| main material group | KELEN |
| material group | KELEN accessories |
| code | K19K |

| Art. No | label |
|---------|-----------|
| 2731710 | 20 4-hole |