

KELEN

K50C KELIT shut-off valve stem 3/4"

2660950

Areas of application

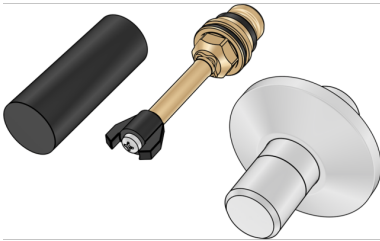

Shut-off valve, incl. chrome-plated end cap, rosette and protection cap, compatible with KE50A and KE50P.

Approvals:



Specifications

Product information	
VPE1	1,00 SA1
VPE2	20,00 KT1
VPE3	80,00 KT2
VPE4	1920,00 PAL
weight	0,244 KGM
text	KELIT shut-off valve stem
INTRNR	84819000
main material group	KELEN
material group	KELEN accessories
code	K50C

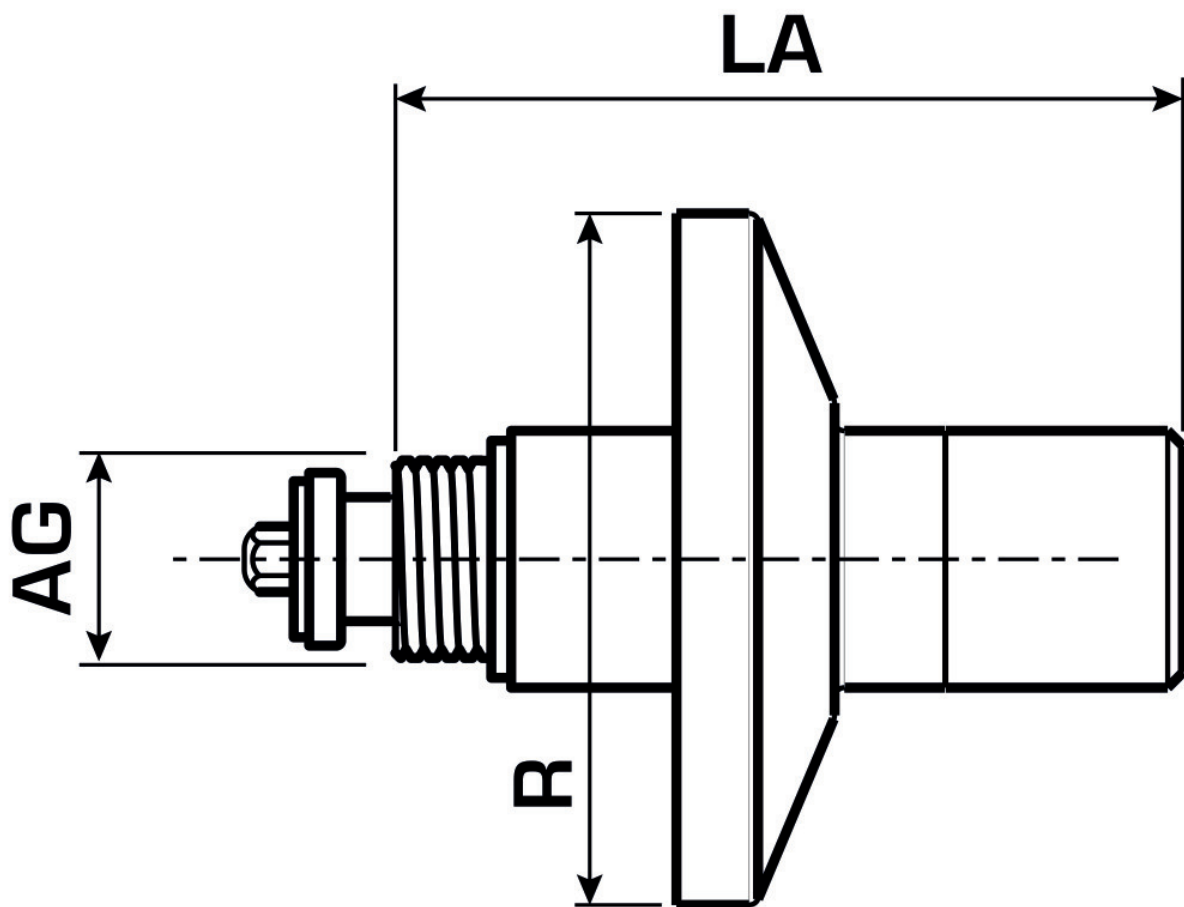

Art. No	label	d1 mm	L1 mm
2660950	3/4"	70	80